



# DISEN®

## PROFESSIONAL TOOLS MANUFACTURER



安徽蒂森五金工具有限公司

ANHUI DISEN TOOLS CO.,LTD

地址：中国安徽省宁国市南山工业园区松岭路11号

Address: No. 11, Songling Road, Nanshan Industrial

Zone, Ningguo City, Anhui Province, China.

电话(Tel): 0086-563-4100118

传真(Fax): 0086-563-4030888

邮编(P.C.): 242300

Https://www.disentools.com

Email:01@disentools.com

EDITION NO.2021

Since 2002



# CERTIFICATE

Strict quality control: BSCI certificate, CE certificate, GS certificate, ISO9001 certificate...



## ABOUT DISEN 关于蒂森















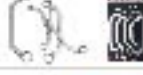

Since **2002**

ANHUI DISEN TOOLS CO.,LTD is a professional manufacturer of hand tools and hydraulic tools in China. The company covers an area of 60000 square meters, and has 50 technical specialists. With 12 wrench production lines and more than 1,000 professional production machinery, the annual output reaches 30 million wrenches. Certified with BSCI, CE, GS, ISO9001, and owning strong technology strength, high-quality products and perfect service system, DISEN has established long-term cooperative relations with many domestic and foreign companies. Sincerely welcome friends for visiting, investigating and business negotiations.

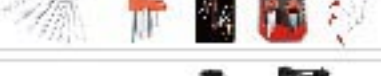

TO BE YOUR PROUD TOOLS—DISEN

# CONTENTS 目录

<b>01</b>	公司简介 <b>Company Introduction</b>		01-04
<b>02</b>	棘轮扳手系列 <b>Ratchet Wrench</b>		05-12
<b>03</b>	摇头套筒 <b>Flexible Socket Wrench</b>		13-14
<b>04</b>	活动扳手 <b>Adjustable Wrench</b>		15-16
<b>05</b>	E型扳手 <b>Star Wrench</b>		17
<b>06</b>	直柄梅花 <b>Long Type Double Ring Spanner</b>		18
<b>07</b>	S型扳手 <b>S Type Double Ring Spanner</b>		19
<b>08</b>	U型梅花扳手 <b>U Type Double Ring Spanner</b>		20
<b>09</b>	油管扳手 <b>Flare Nut Wrench</b>		21-22
<b>10</b>	扳手系列 <b>Spanner</b>		23-46
<b>11</b>	万能扳手 <b>Universal Wrench</b>		47
<b>12</b>	拉马 <b>Puller</b>		48
<b>13</b>	8合1 <b>8 in1 Combination Wrench</b>		48
<b>14</b>	T型套筒 <b>T- Type Wrench</b>		49
<b>15</b>	磁性套筒 <b>Magnetic Nut Socket</b>		50
<b>16</b>	三叉扳手 <b>Y-type Wrench</b>		50
<b>17</b>	内六角扳手 <b>Hex Key</b>		51-60
<b>18</b>	套筒系列 <b>Socket Set</b>		61-82

# CORPORATE ENVIRONMENT 公司环境



办公区  
Office



锻压模具加工  
Drop Forged Mould Processing



扳手锻压加工  
Forged And Processing



扳手金加工  
Machine Processing



毛坯仓库  
Semifinished Product Warehouseing



扳手滚筒加工  
Cylinder Grind Processing



自动抛光加工  
Automatic Polish Processing



棘轮扳手机加工  
Lathe Processing



内六角扳手加工  
Hex Key Processing



扳手冷挤压加工  
Cold Extruding Processing



钣金车间  
Metal Workshop



热处理车间  
Heat Treatment Workshop



电镀车间  
Electroplating Workshop

# Ratchet Wrench

## 棘轮扳手系列



- .Ratchet material CRV 50BV30
- .72-tooth Ratchet Gears Need Only 5°
- .Flexible ratchet wrench can apply in narrow spots where a ratchet will not fit in

## Stubby Ratchet Wrench 粗短柄棘轮扳手

Code:KT2016(Mirror) KT2016S(Satin) KT2016M(Matt) KT2016B(Black) KT2016G(Golden)

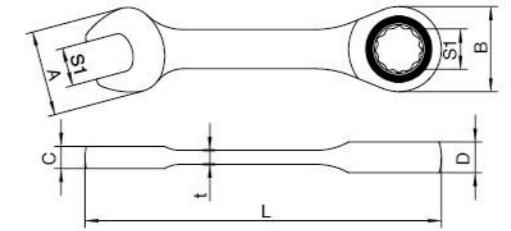

MM	A	B	S1	C	D	t	L	PCS
6	13.6	17.7	6	4.6	7.2	3	81	480
7	17.08	17.7	7	5.3	7.2	3.6	89	480
8	17.08	17.7	8	5.3	7.2	3.6	89	480
9	19.2	19.2	9	5.7	7.9	3.7	92	480
10	21.3	22.1	10	6	8.4	3.8	95	480
11	23.42	23.4	11	6.4	8.9	4	103	480
12	25.52	25.4	12	6.6	9.3	4.2	106	240
13	27.63	26.9	13	6.8	9.8	4.4	108	240
14	29.72	28.5	14	7.1	10.2	4.6	115	180
15	31.82	30.1	15	7.4	10.7	4.8	119	180
16	35	31.95	16	7.7	11.1	5	123	180
17	36.8	33.3	17	7.9	11.6	5.2	127	180
18	38.5	34.8	18	8.6	12.1	5.5	132	120
19	40	36.1	19	8.8	12.1	5.7	139	120

## Flexible Ratchet Wrench 活动头棘轮扳手

Code:KT2012(Mirror) KT2012S(Satin) KT2012M(Matt) KT2012B(Black) KT2012G(Golden)

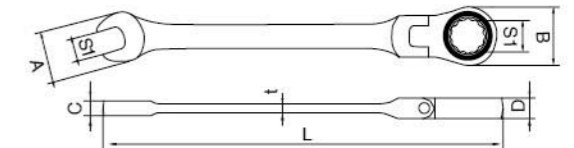

MM	SAE	A	B	S1	C	D	t	L	PCS	MEAS
6	1/4	13.6	17.7	6	4.6	6.6	3	126	240	275x160x135
7		16.4	17.7	7	4.8	6.6	3.2	134	240	275x160x135
8	5/16	17.08	17.7	8	5.3	6.6	3.6	140	240	275x160x135
9		19.2	19.2	9	5.7	7.3	3.7	150	240	320x180x185
10	3/8	21.3	22.1	10	6	7.8	3.8	162	240	320x180x185
11	7/16	23.42	23.4	11	6.4	8.3	4	168	240	335x185x185
12		25.52	25.4	12	6.6	8.7	4.2	172	200	360x200x170
13	1/2	27.63	26.9	13	6.8	9.1	4.4	181	200	360x200x170
14	9/16	29.72	28.5	14	7.1	9.5	4.6	192	150	260x220x225
15		31.82	30.1	15	7.4	10	4.8	202	150	260x220x225
16	5/8	35	32	16	7.7	10.4	5	210	120	340x240x175
17		36.8	33.3	17	7.9	10.8	5.2	227	120	350x260x190
18	11/16	38.5	34.8	18	8.6	11.3	5.5	238	100	295x260x190
19	3/4	40	36.1	19	8.8	11.3	5.7	248	100	315x270x200
20		46.3	42.2	20	9.2	13.1	6.2	294	80	300x310x220
21	13/16	46.3	42.2	21	9.2	13.1	6.2	294	80	300x310x220
22	7/8	46.3	42.2	22	9.2	13.1	6.2	294	80	300x310x220
23		51.8	49.2	23	10	14.6	6.8	332	50	350x310x165
24	15/16	51.8	49.2	24	10	14.6	6.8	332	50	350x310x165
25	1	51.8	49.2	25	10	14.6	6.8	332	50	350x310x165
26		56.5	53.2	26	10.8	15.6	7.2	344	40	385x275x175
27	1-1/16	56.5	53.2	27	10.8	15.6	7.2	344	40	385x275x175
28		62.7	58.5	28	12	17.1	8.2	387	30	420x276x150
29	1-1/8	62.7	58.5	29	12	17.1	8.2	387	30	420x276x150
30		62.7	58.5	30	12	17.1	8.2	387	30	420x276x150
32	1-1/4	66.5	62	32	12.5	17.6	8.5	407	30	445x225x195
34		66.5	62	34	12.5	17.6	8.5	407	20	520x240x180
36		78.5	71	36	14	17.6	10	442	20	520x240x180
38		78.5	71	38	14	17.6	10	442	20	520x240x180

### Flex-Head Double Box End Ratcheting Wrench 双头活动头棘轮扳手

Code:KT2018(Mirror) KT2018S(Satin) KT2018M(Matt) KT2018B(Black) KT2018G(Golden)



MM	A	B	C	D	t	L	PCS
8x9	17.5	19	6.6	7.3	3.6	163	240
10x11	21.8	23.1	7.8	8.3	3.8	183	240
12x13	25	26.5	8.7	9.1	4.2	206	200
14x15	28	29.6	9.5	10	4.6	217	150
16x17	31.5	32.7	10.4	10.8	5	236	120
18x19	34.2	35.5	11.3	11.3	5.6	258	100

### Long Type Joint Flexible Head Double Rings Ratchet Wrench 加长关节活动头双梅花棘轮扳手

加长关节活动头双梅花棘轮扳手



MM	SAE	A	B	C	D	t	L
8x9	5/16x3/8	17.8	19.6	6.6	7.3	3.7	277.9
10x11	3/8x7/16	21.0	22.8	7.8	8.3	4	352
12x13	7/16x1/2	24.2	25.8	8.7	9.1	4.4	391
14x15	1/2x9/16	27.4	29.0	9.5	10	4.8	436.8
16x18		31.5	34.2	10.4	11.3	5.6	484.4
17x19		34.0	35.8	10.8	11.3	5.7	488.5

### Long Type Flexible Ratchet Wrench 加长活动头双梅花棘轮扳手

Code:KT2017(Mirror) KT2017S(Satin) KT2017M(Matt) KT2017B(Black) KT2017G(Golden)



MM	SAE	A	B	C	D	t	L	PCS
8x9	5/16x3/8	17.8	19.6	6.6	7.3	3.7	232	120
10x11	3/8x7/16	21.0	22.8	7.8	8.3	4	298	120
12x13	7/16x1/2	24.2	25.8	8.7	9.1	4.4	328	120
14x15	1/2x9/16	27.4	29.0	9.5	10	4.8	370	120
16x18		31.5	34.2	10.4	11.3	5.6	408	60
17x19		34.0	35.8	10.8	11.3	5.7	412	60

### Long Type Flexible Ratchet Wrench Set 加长活动头双梅花棘轮扳手 6PCS

加长活动头双梅花棘轮扳手 6PCS



Code: KT2017D



Code:KT2017P

CODE	SIZE	SIZE $\downarrow$ mm	装箱数 (PCS)	体积 (MEASURE)
KT2017D	6PCS	8X9, 10X11, 12X13, 14X15, 16X18, 17X19	30	430x300x163
KT2017P	6PCS	8X9, 10X11, 12X13, 14X15, 16X18, 17X19	30	515x155x240

### Fixed Ratchet Wrench 单头棘轮扳手

单头棘轮扳手

Code:KT2011(Mirror) KT2011S(Satin)

KT2011M(Matt) KT2011B(Black)

KT2011G(Golden)

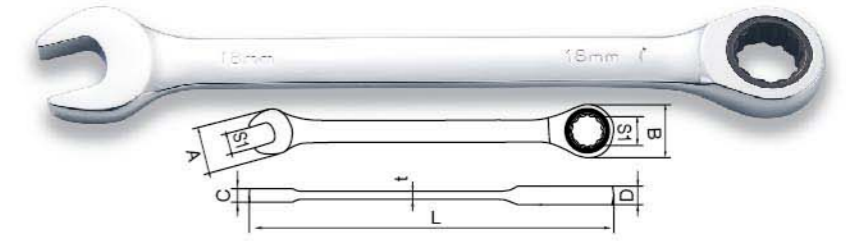

MM	SAE	A	B	S1	C	D	t	L	PCS	MEAS
6	1/4	13.6	17.7	6	4.6	6.6	3	126	240	275x160x135
7		16.4	17.7	7	4.8	6.6	3.2	134	240	275x160x135
8	5/16	17.1	17.7	8	5.3	6.6	3.6	140	240	275x160x135
9		19.2	19.2	9	5.7	7.3	3.7	150	240	320x180x185
10	3/8	21.3	22.1	10	6	7.8	3.8	160	240	320x180x185
11	7/16	23.4	23.4	11	6.4	8.3	4	166	240	335x185x185
12		25.5	25.4	12	6.6	8.7	4.2	172	200	360x200x170
13	1/2	27.6	26.9	13	6.8	9.1	4.4	179	200	360x200x170
14	9/16	29.7	28.5	14	7.1	9.5	4.6	192	150	260x220x225
15		31.8	30.1	15	7.4	10	4.8	210	150	260x220x225
16	5/8	35	31.9	16	7.7	10.4	5	210	120	340x240x175
17		36.8	33.3	17	7.9	10.8	5.2	226	120	350x260x190
18	11/16	38.5	34.8	18	8.6	11.3	5.5	238	100	295x260x190
19	3/4	40	36.1	19	8.8	11.3	5.7	247	100	315x270x200
20		46.3	42.2	20	9.2	13.1	6.2	293	80	300x310x220
21	13/16	46.3	42.2	21	9.2	13.1	6.2	293	80	300x310x220
22	7/8	46.3	42.2	22	9.2	13.1	6.2	293	80	300x310x220
23		51.8	49.2	23	10	14.6	6.8	335	50	350x310x165
24	15/16	51.8	49.2	24	10	14.6	6.8	335	50	350x310x165
25	1	51.8	49.2	25	10	14.6	6.8	335	50	350x310x165
26		56.5	53.2	26	10.8	15.6	7.2	359	40	385x275x175
27	1-1/16	56.5	53.2	27	10.8	15.6	7.2	359	40	385x275x175
28		62.7	58.5	28	12	17.1	8.2	405	30	420x276x150
29	1-1/8	62.7	58.5	29	12	17.1	8.2	405	30	420x276x150
30		62.7	58.5	30	12	17.1	8.2	405	30	420x276x150
32	1-1/4	66.5	62	32	12.5	17.6	8.5	425	30	445x225x195
34	1-1/4	66.5	62	34	12.5	17.6	8.5	425	30	520x240x180
36		78.5	71	36	14	17.6	10	442	20	520x240x180
38		78.5	71	38	14	17.6	10	442	20	520x240x180

### Reversible Ratchet Wrench 单头双向棘轮扳手

单头双向棘轮扳手

Code:KT2013(Mirror) KT2013S(Satin) KT2013M(Matt)

KT2013B(Black) KT2013G(Golden)

Made of Chrome Vanadium Steel .Hardened and Tempered  
.Three Layers Chrome Plated .Lifetime Warranty

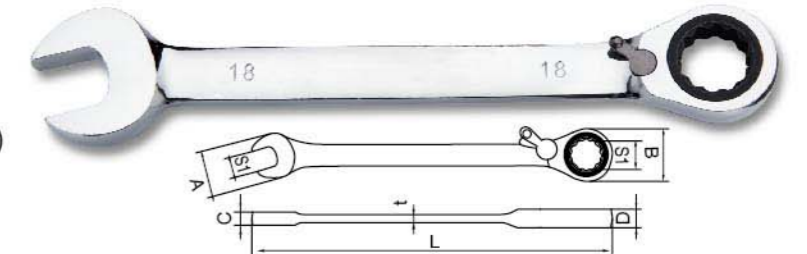

MM	SAE	A	B	S1	C	D	t	L	PCS	MEAS
6	1/4	13.6	17.7	6	4.6	6.6	3	126	240	275x160x135
7		16.4	17.7	7	4.8	6.6	3.2	134	240	275x160x135
8	5/16	17.1	17.7	8	5.3	6.6	3.6	140	240	275x160x135
9		19.2	19.2	9	5.7	7.3	3.7	150	240	320x180x185
10	3/8	21.3	22.1	10	6	7.8	3.8	160	240	320x180x185
11	7/16	23.4	23.4	11	6.4	8.3	4	166	240	335x185x185
12		25.5	25.4	12	6.6	8.7	4.2	172	200	360x200x170
13	1/2	27.6	26.9	13	6.8	9.1	4.4	179	200	360x200x170
14	9/16	29.7	28.5	14	7.1	9.5	4.6	192	150	260x220x225
15		31.8	30.1	15	7.4	10	4.8	210	150	260x220x225
16	5/8	35	31.9	16	7.7	10.4	5	210	120	340x240x175
17		36.8	33.3	17	7.9	10.8	5.2	226	120	350x260x190
18	11/16	38.5	34.8	18	8.6	11.3	5.5	238	100	295x260x190
19	3/4	40	36.1	19	8.8	11.3	5.7	247	100	315x270x200
20		46.3	42.2	20	9.2	13.1	6.2	293	80	300x310x220
21	13/16	46.3	42.2	21	9.2	13.1	6.2	293	80	300x310x220
22	7/8	46.3	42.2	22	9.2	13.1	6.2	293	80	300x310x220
23		51.8	49.2	23	10	14.6	6.8	335	50	350x310x165
24	15/16	51.8	49.2	24	10	14.6	6.8	335	50	350x310x165
25	1	51.8	49.2	25	10	14.6	6.8	335	50	350x310x165
26		56.5	53.2	26	10.8	15.6	7.2	359	40	385x275x175
27	1-1/16	56.5	53.2	27	10.8	15.6	7.2	359	40	385x275x175
28		62.7	58.5	28	12	17.1	8.2	405	30	420x276x150
29	1-1/8	62.7	58.5	29	12	17.1	8.2	405	30	420x276x150
30		62.7	58.5	30	12	17.1	8.2	405	30	420x276x150
32	1-1/4	66.5	62	32	12.5	17.6	8.5	425	30	445x225x195

### Double Reversible Ratchet Wrench

双头双向棘轮扳手

Code:KT2015(Mirror) KT2015S(Satin)  
KT2015M(Matt) KT2015B(Black)  
KT2015G(Golden)



### Double Offset Ring Ratchet Wrench

双头单向棘轮扳手

Code:KT2014(Mirror) KT2014S(Satin)  
KT2014M(Matt) KT2014B(Black)  
KT2014G(Golden)

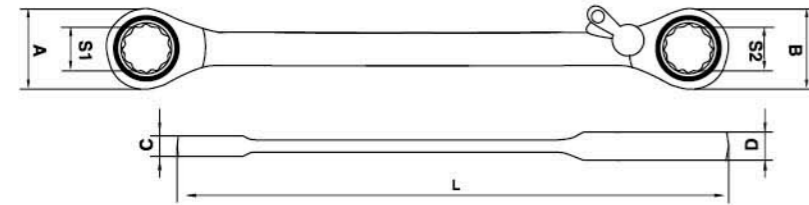

.Made of Chrome Vanadium Steel  
/Carbon Steel  
.Hardened and Tempered  
.Three Layers Chrome Plated  
.Lifetime Warranty

SIZE	SAE	A	B	S1	S2	C	D	L	PCS
8X9	5/16x3/8	18.7	20.3	8	9	6.6	7.3	135	240
8X10		18.6	22.1	8	10	6.6	7.8	135	240
10X11	3/8x7/16	19	23	10	11	7.8	8.3	135	240
10X12		22.1	25.8	10	12	7.8	8.7	159	240
10X13		22.1	27	10	13	7.8	9.1	159	240
12X13	7/16x1/2	25.8	27	12	13	8.7	9.1	176	200
12X14		25.8	29	12	14	8.7	9.5	180	200
13X14		27	29	13	14	9.1	9.5	180	200
14X15	1/2x9/16	28.9	30.3	14	15	9.5	10	197	200
14X17		29	33.2	14	17	9.5	10.8	205	150
16X17	5/8x11/16	32	33.2	16	17	10.4	10.8	215	150
17X19		33.2	36.6	17	19	10.8	11.3	237	100
18X19		35.6	36.6	18	19	11.3	11.3	237	100

### Available Finish

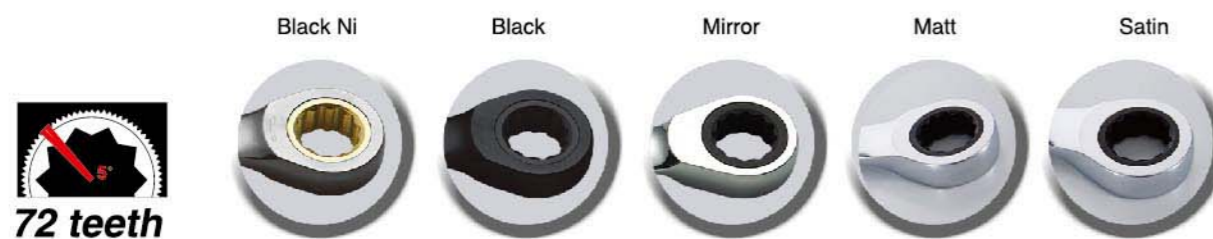

### Ratchet Wrench Bag Set

棘轮扳手挂袋套装

.Made of Chrome Vanadium Steel .Hardened and Tempered  
.Three Layers Chrome Plated/Matt Finish . Lifetime Warranty



型号 METRIC SIZE	SIZE mm	装箱数 PCS	重量 Kg	体积 mm
KTP 5pcs(8-14)	8,10,12,13,14	20	9	255x200x170
KTP 6pcs(8-17)	8,10,12,13,14,17	20	11	255x200x170
KTP 7pcs(8-19)	8,10,12,13,14,17,19	20	14.5	285x235x178
KTP 8pcs(8-19)	8,10,12,13,14,15,17,19	20	23.5	310x300x170
KTP 9pcs(8-19)	8,10,11,12,13,14,15,17,19	10	13.5	395x180x160
KTP 10pcs(8-19)	8,10,12,13,14,15,16,127,18,19	10	13.5	315x215x145
KTP 11pcs(8-19)	8,9,10,11,12,13,14,15,16,17,19	10	14.5	320x245x155
KTP 12pcs(8-19)	8,9,10,11,12,13,14,15,16,17,18,19	10	14.5	320x245x155
KTP 13pcs(8-32)	8,10,12,13,14,17,19,21,22,24,27,30,32	10	30	420x270x190
KTP 14pcs(6-19)	6,7,8,9,10,11,12,13,14,15,16,17,18,19	10	30	420x270x190
KTP 20pcs(6-32)	6,7,8,9,10,11,12,13,14,15,16,17,18,19,21,22,24,27,30,32	5	18.5	495x190x155
KTP 22pcs(6-32)	6,7,8,9,10,11,12,13,14,15,16,17,18,19,20,21,22,23,24,25,26,27,30,32	5	20	495x190x155
KTP 5pcs(3/8-5/8)	3/8,7/16,1/2,9/16,5/8	20	9	255x200x170
KTP 12pcs(8-19)	8,3/8,10,11,12,13,1/2,9/16,15,16,11/16,19	10	14.5	320x245x155

### Double Offset Ring Ratchet Wrench Bag Set

双头梅花棘轮扳手挂袋套装

.Made of Chrome Vanadium Steel .Hardened and Tempered  
.Three Layers Chrome Plated/Matt Finish . Lifetime Warranty



型号 METRIC SIZE	SIZE mm	装箱数 PCS	重量 Kg	体积 mm
5pcs(8-17)	8X9,10X11,10X12,12X13,14X17mm	20	10	255x200x170
6pcs(8-19)	8X9, 10X11,12X13,14X15,16X17,18X19mm	20	12.5	255x200x170
7pcs(8-22)	8X9,10X11,12X13,14X15,16X17,18X19,20x22mm	20	15.5	285x235x178

### Ratchet Wrench Plastic Holder Set

棘轮扳手塑架套装



型号 METRIC SIZE	SIZE ↓ mm	装箱数 PCS	体积 MEASURE
5pcs(8-14)	8,10,12,13,14	30	445x330x380
6pcs(8-17)	8,10,12,13,14,17	30	445x330x380
7pcs(8-17)	8,10,12,13,14,17,19	20	450x355x260
8pcs(8-19)	8,10,12,13,14,15,17,19	20	400x365x425
9pcs(8-19)	8,10,11,12,13,14,15,17,19	20	400x365x425
11pcs(8-19)	8,9,10,11,12,13,14,15,16,17,19	10	520x385x230
14pcs(6-19)	8,9,10,11,12,13,14,15,16,17,18,19	5	305x235x270
6pcs(8-19)	8X9,10X11,12X13,14X15,16X17,18X19	30	445x330x380
6pcs(8-19)	8X9,10X11,12X13,14X15,16X17,18X19	30	430x285x380
7pcs(8-22)	8X9,10X11,12X13,14X15,16X17,18X19,20x22mm	20	450x360x400

### Ratchet Wrench Blow Case Set 棘轮扳手塑盒套装



Code	型号 METRIC SIZE	SIZE ↓ mm	装箱数 PCS	重量 Kg	PACKAGE SIZE(cm)	
					Blow Case	Color Box
DSD1601	12PCS(8mm-19mm)	8,9,10,11,12,13,14,15,16,17,18,19,	10	19	300x205x55	425x315x285
DSS1602	13PCS(8mm-32mm)	8,10,12,13,14,17,19,21,22,24,27,30,32	3	17.8	465x305x63	485x215x320
DSS1603	22PCS(6mm-32mm)	6,7,8,9,10,11,12,13,14,15,16,17,18,19,20,21,22,23,24,27,30,32	3	23.5	495x360x63	515x210x375

.Made of Chrome Vanadium Steel.Hardened and Tempered  
.Three Layers Chrome Plated/Matt Finish. Lifetime Warranty

### Ratchet Wrench Aluminum Case Set 棘轮扳手铝盒套装



Code	型号 METRIC SIZE	SIZE ↓ mm	装箱数 PCS	重量 Kg	PACKAGE SIZE(cm)	
					Blow Case	Color Box
DSL1701	13PCS(8mm-32mm)	8,10,12,13,14,17,19,21,22,24,27,30,32	3	21.5	480x360x110	500x380x365
DSL1702	22PCS(6mm-24mm)	6,7,8,9,10,11,12,13,14,15,16,17,18,19,20,21,22,23,24,27,30,32	2	17	620x330x70	640x350x175

.Made of Chrome Vanadium Steel.Hardened and Tempered  
.Three Layers Chrome Plated/Matt Finish . Lifetime Warranty

# FLEXIBLE SOCKET WRENCH

## 摇头套筒扳手



- Made of Chrome Vanadium Steel
- Hardened and Tempered
- Three Layers Chrome Plated
- Lifetime Warranty

fast delivery / quality assurance / customer satisfaction / shipment consolidation / information online  
 competitive price / research development / innovative products

# Flexible Socket Wrench 摇头套筒扳手

Code:YT101(Mirror) YT102(Matt)

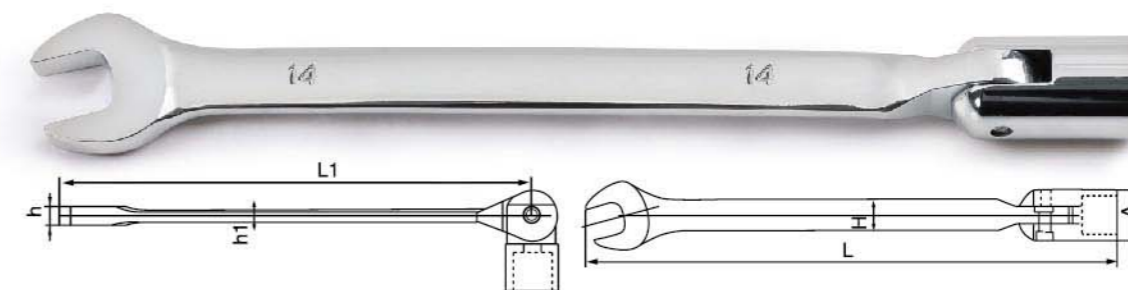

MM	L	L1	A	H	h	h1
8	163	142	13	9.5	6	4.1
9	163	142	13	9.5	6	4.1
10	178	155	15.8	10.8	6.6	4.4
11	178	155	15.8	10.8	6.6	4.4
12	200	172	18.8	12.5	6.9	4.6
13	200	172	18.8	12.5	6.9	4.6
14	225	194	20.8	13.9	7.5	4.8
15	225	194	20.8	13.9	7.5	4.8
16	230	199	23.8	15.4	8.1	5.1
17	230	199	23.8	15.4	8.1	5.1
18	245	211	25.8	17.2	9	5.6
19	245	211	25.8	17.2	9	5.6
20	259	225	29.8	19.4	9.9	6
21	259	225	29.8	19.4	9.9	6
22	259	225	29.8	19.4	9.9	6
23	276	235	31.8	22.3	10.4	6.5

# Double Flexible Socket Wrench 双摇头套筒扳手

Code:SYT101(Mirror) SYT102(Matt)

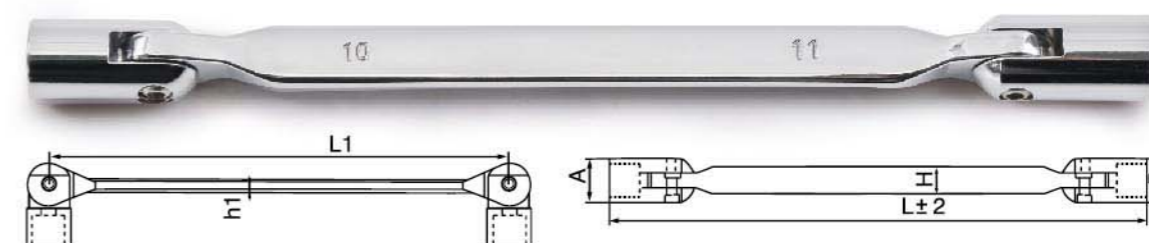

MM	L	L1	A	B	H	h
8x9	183	141	13	13	10.2	4.2
8x10	185	141	13	15.8	10.2	4.2
10x11	200	152	15.8	15.8	11.7	4.6
10x12	203	152	15.8	18.8	11.7	4.6
12x13	223	167	18.8	18.8	13.7	5.1
12x14	227	167	18.8	20.8	13.7	5.1
14x15	244	182	20.8	20.8	14.5	5.6
14x17	244	182	20.8	23.8	14.5	5.6
16x17	254	191	23.8	23.8	15.5	6.3
17x19	278	210	23.8	25.8	15.8	6.8
18x19	280	210	25.8	25.8	15.8	6.8
20x22	295	219	29.8	31.8	17.4	8.2

# ADJUSTABLE WRENCH

## 活动扳手



Code: KT401 KT402 KT403 KT404

SIZE	PCS	L	MAX SIZE	MEAS
6" 150mm	240	150mm	19	385x175x300
8" 200mm	120	200mm	24	290x225x280
10" 250mm	60	250mm	30	355x270x160
12" 300mm	48	300mm	36	320x325x185
15" 375mm	20	375mm	46	395x235x205
18" 450mm	12	450mm	55	475x265x155
24" 600mm	6	600mm	65	615x240x160

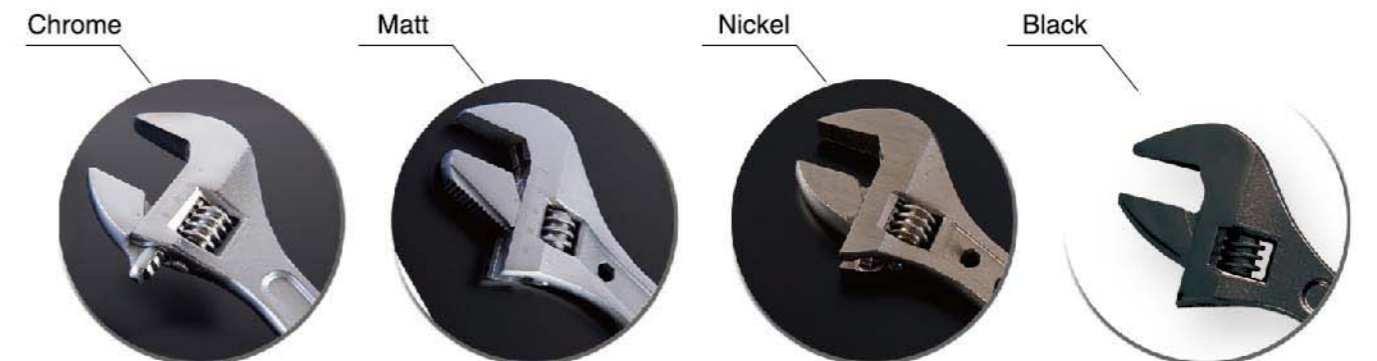
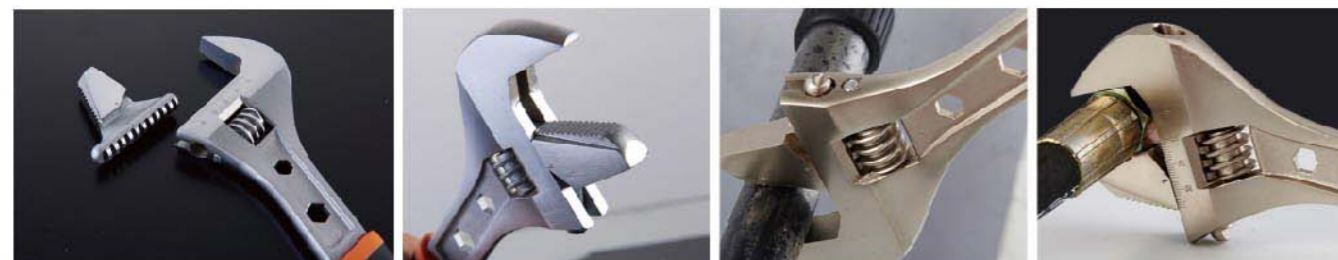

### Star Wrench E型扳手



Code:KTE605S(Satin )

MM	A	B	S1	C	D	S2	t	L	PCS
E6*E8	10.2	11.3	6	4.9	5.9	8	3.5	113.1	300
E7*E11	10	14	7	5.4	7.9	11	4.2	127	300
E10*E12	13	15	10	7.4	8.4	12	4.8	140.9	300
E14*E18	16.9	21	14	8	9.4	18	5.3	181.9	200
E16*E22	19	26.1	16	8.7	11.8	22	5.9	202.3	200
E20*E24	23.9	28.1	20	10.8	12.8	24	6.5	225.5	150

### Star Wrench Set

E型扳手 4PCS

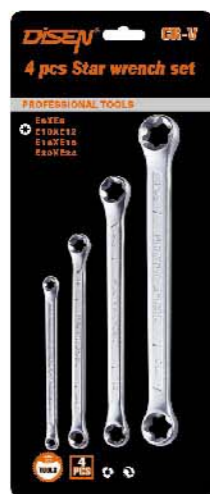

Code:KTE605D



Code:KTE605P

CODE	SIZE	SIZE $\downarrow$ $\odot$	装箱数 (PCS)	体积 (MEASURE)
KTE605D	4PCS	E6xE8 E10xE12 E14xE18 E20xE24	60	415x325x275
KTE605P	4PCS	E6xE8 E10xE12 E14xE18 E20xE24	60	415x325x275

### Long Type Double Ring Spanner 直柄梅花

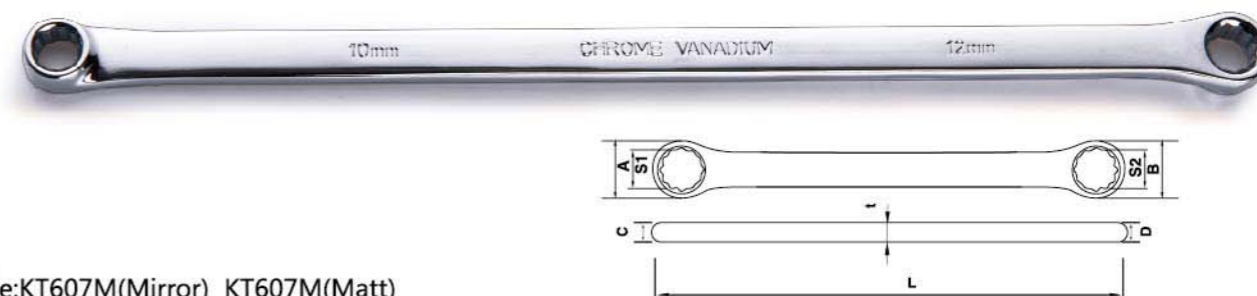

Code:KT607M(Mirror) KT607M(Matt)

MM	A	B	S1	C	D	S2	t	L	PCS
8*10	14.2	17.5	8	7.5	9	10	5	237	200
10*11	20.5	23.4	10	10.5	11	11	6	332	100
11*13	20.5	23.4	11	10.5	11	13	6	332	100
12*14	20.5	23.4	12	10.5	11	14	6	332	100
13*15	23.7	25	13	12	12	15	6.5	374	50
14*15	23.7	25	14	12	12	15	6.5	374	50
15*17	26.3	28.5	15	14	14	17	7	411	50
16*17	26.3	28.5	16	14	14	17	7	411	50
16*18	29.8	30.8	16	14	14	18	7	414	50
17*19	29.8	30.8	17	14	14	19	7	414	50
18*19	29.8	30.8	18	14	14	19	7	414	50
19*21	32.1	33.2	19	14	14	21	7	422	50
20*21	32.1	33.2	20	14	14	21	7	422	30
22*24	35.2	38.2	22	15	16	21	8	434	30

### Long Type Double Ring Spanner Set

直柄梅花 6PCS



Code:KT607D



Code:KT607P

CODE	SIZE	SIZE $\downarrow$ $\odot$	装箱数 (PCS)	体积 (MEASURE)
KTE607D	6PCS	8x10 11x13 12x14 15x17 16x18 19x21	30	430x300x163
KTE607P	6PCS	8x10 11x13 12x14 15x17 16x18 19x21	30	430x300x163

**S Type Double Ring Spanner** S型扳手

**U Type Double Ring Spanner** U型梅花扳手

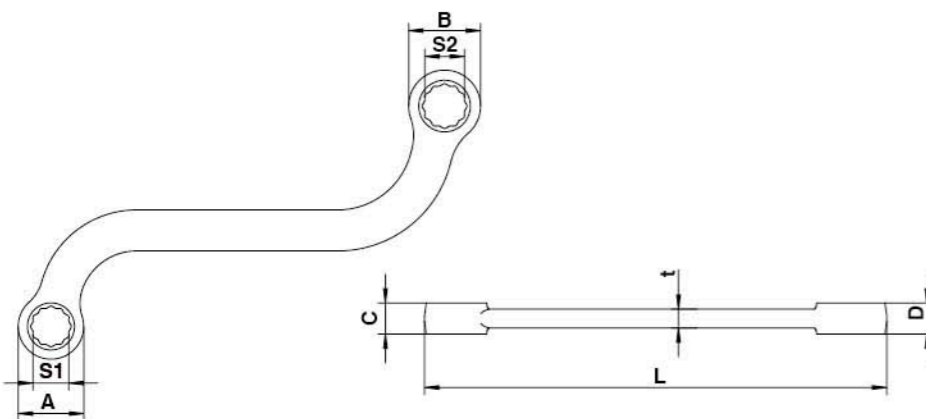

Code:KT901

SIZE	A	S1	B	S2	C	D	t	L
10x11	18.2	10	20	11	8.4	8.6	5.2	129
12x13	21	12	22.1	13	8.8	9	5.4	143
14x15	23.9	14	25.7	15	11.1	11.3	5.9	173
16x17	27	16	28.6	17	11.4	11.6	6.2	203
18x19	29.3	18	30.5	19	11.8	12	6.6	216

Code:KT901D

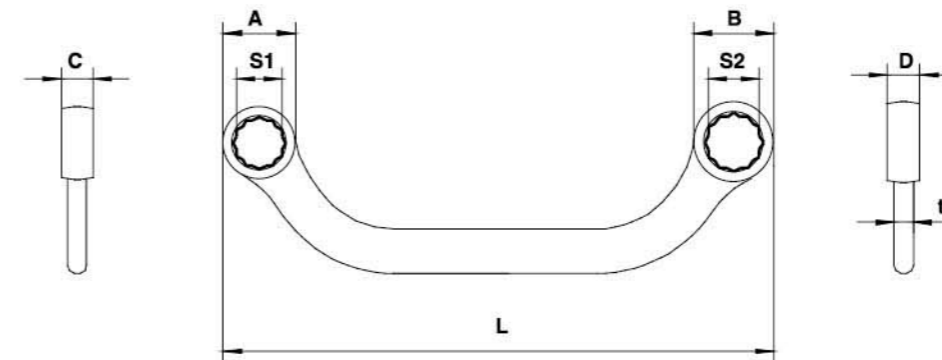
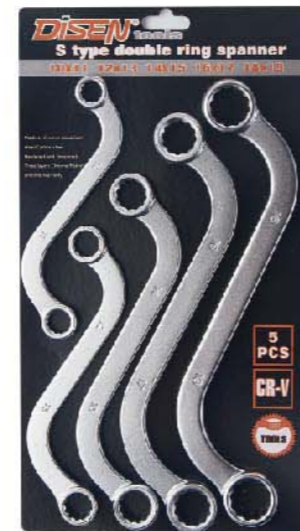

Code:KT902

SIZE	A	S1	B	S2	C	D	t	L
8x10	17	8	19.8	10	8.3	8.5	5	131
11x13	20	11	22.2	13	8.7	8.9	5.3	152
14x15	23.8	14	25.5	15	10.1	10.3	5.7	173
17x19	28.4	17	30.2	19	11.8	12	6.4	199
21x22	33.6	21	36.8	22	12.6	12.6	6.6	231

Code:KT902D



# Flare Nut Wrench 油管扳手



- Made of Chrome Vanadium Steel
- Hardened and Tempered
- Three Layers Chrome Plated
- Lifetime Warranty

fast delivery / quality assurance / customer satisfaction / shipment consolidation / information online  
competitive price / research development / innovative products

## Flare Nut Wrench 油管扳手

Code: KT903(Mirror)  
KT903S(Satin)  
KT903M(Matt)

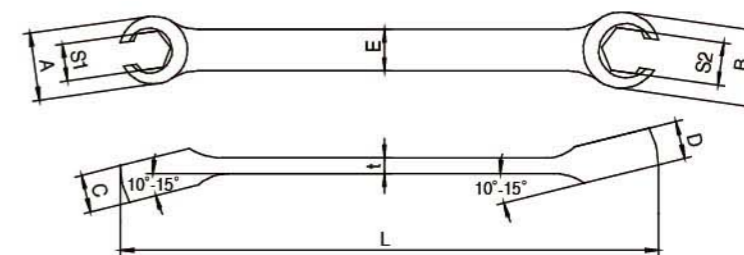

.Made of Chrome Vanadium Steel / Carbon Steel  
.Hardened and Tempered  
.Three Layers Chrome Plated  
.Lifetime Warranty

MM	A	S1	B	S2	C	D	t	L	PCS	MEAS
6*7 ( 8 )	14.2	6	17.8	8	7.6	8.6	4.4	128	250	310x185x240
8*9 ( 10 )	17.8	8	20.8	10	8.7	9.6	4.6	144	250	310x185x240
9*11	19.8	9	22.7	11	9.1	9.9	4.9	153	250	335x200x245
10*11 ( 12 )	20.8	10	23.4	13	9.9	10.9	5.2	165	250	335x200x245
10*13	20.8	10	23.4	12	9.9	10.9	5.2	165	250	335x200x245
12*13 ( 14 )	24.7	12	25.9	14	10.6	11.4	5.6	175	250	345x215x275
13 ( 14 ) *15	24.7	13	25.9	14	10.6	11.4	5.6	175	250	345x215x275
14*15 ( 17 )	29	14	32.3	17	12.2	13.5	6.1	195	150	495x225x190
15*17	29	15	32.3	17	12.2	13.5	6.1	195	150	495x225x190
16*17 ( 18 )	32.3	16	36	18	13.5	14	6.6	214	100	360x265x230
17 ( 18 ) *19	32.3	17	36	19	13.5	14	6.6	214	100	360x265x230
19*21 ( 22 )	36	19	42.5	22	14	14.5	6.9	234	100	375x280x205
21*23	42.5	22	44.5	24	14.5	15.5	7.3	252	60	375x280x205
22*24	42.5	22	44.5	24	14.5	15.5	7.3	252	60	375x280x205
24*27	45.5	24	49.5	27	16	17.5	8	268	40	290x205x215

## Flare Nut Wrench Bag Set 油管扳手挂袋套装

Code:KT903P(Mirror) KT903SP(Satin) KT903MP(Matt)

型号 METRIC SIZE	SIZE mm	装箱数 PCS	重量 kg	体积 mm
4PC:5/16mm-3/4mm	5/16x3/8,7/16x1/2,9/16x5/8,11/16x3/4mm	20	28	320x245x155
5PC:8mm-19mm	8x10,9x11,10x12,14x17,17x19mm	20	30	470x394x160
6PC:8mm-18mm	8x10,9x11,10x12,13x14,15x17,16x18mm	20	30	380x315x295
7PC:6mm-22mm	6x8,9x11,10x12,13x14,15x17,16x18,20x22mm	20	32	475x420x175
8PC:6mm-22mm	6x8,9x11,13x14,15x17,16x18,17x19,19x22mm	20	32	475x420x175



# PROFESSIONAL TOOLS

## HIGH QUALITY

- .Made of Chrome Vanadium Steel / Carbon Steel
- .Hardened and Tempered
- .Three Layers Chrome Plated
- .Available Finish: Mirror Chrome Plated, Matt Chrome Plated, Satin Chrome Plated, Black Nickel, Black



Matt



Rubber



Black



Golden



Satin



Mirror

### Recessed Panel Combination Spanner 两用扳手

Code:KT701(Mirror) KT701S(Satin) KT701M(Matt) KT701B(Black) KT701R(Rubber) KT701G(Golden)



- .Made of Chrome Vanadium Steel / Carbon Steel
- .Hardened and Tempered
- .Three Layers Chrome Plated
- .Lifetime Warranty

MM	SAE	A	B	S1	C	D	t	L	PCS	MEAS
6	1/4	13.5	10.8	6	4.1	4.9	2.9	111	300	375*140*145
7		15.3	12.3	7	4.6	5.3	3.2	121	300	375*140*145
8	5/16	17.7	14	8	5.1	6.3	3.3	125	300	365*150*155
9		20	15.2	9	5.5	6.7	3.7	128	300	375*160*155
10	3/8	21.7	16.6	10	5.5	6.8	3.8	131	300	375*160*155
11	7/16	23.2	18.2	11	5.8	7.2	3.9	142	300	395*165*175
12		26.1	19.6	12	6.1	7.5	4	152	250	395*180*160
13	1/2	27.7	20.6	13	6.3	7.8	4	160	250	395*180*160
14	9/16	30.1	22.3	14	6.5	8.1	4.1	173	250	415*200*170
15		32	23.6	15	6.7	8.2	4.3	183	150	260*220*230
16	5/8	33.9	25.2	16	6.8	8.3	4.3	195	100	275*220*160
17		35.2	26.1	17	6.9	8.4	4.5	208	100	285*235*180
18	11/16	37.4	27.7	18	7.4	8.5	5.1	219	100	285*235*180
19	3/4	39.4	29.1	19	7.7	9.7	5.1	231	100	295*260*190
20		40.8	30.4	20	7.7	9.9	5.4	240	60	260*240*150
21	13/16	42.5	32.2	21	8	10.1	5.6	251	60	290*275*165
22	7/8	44.3	33.4	22	8.2	10.3	5.7	264	60	290*275*165
23		45.3	33.8	23	8.3	10.5	5.8	273	60	290*275*165
24	15/16	49.3	36.1	24	8.8	11.7	6.1	287	60	310*300*170
25	1	51.2	38.2	25	9.1	12.3	6.5	297	60	330*315*190
26		51.2	38.2	26	9.1	12.3	6.5	297	60	330*315*190
27	1-1/16	54.2	39.6	27	9.3	12.5	6.6	308	30	330*240*135
28		57.5	43.2	28	10.6	13.6	7	330	30	385*258*145
29	1-1/8	57.5	43.2	29	10.6	13.6	7	330	30	385*258*145
30	1-3/16	59	44	30	10.9	13.7	7.5	342	30	385*258*145
32	1-1/4	63.7	46.7	32	11.1	13.9	7.5	356	30	385*258*145
34		67.7	51.6	34	11.4	15	7.6	387	30	420*276*150
36		70	55.5	36	12.1	16.2	8.1	411	30	435*300*165
38		77.2	58.1	38	13.5	17	9.8	440	30	485*310*175
41		83.7	61.4	41	13.6	18.3	10.3	451	20	495*210*205
46		89.8	66.7	46	14.5	18.8	11.1	474	20	495*210*205

#### Available Finish



### Combination Spanner 两用扳手

Code:KT702(Mirror) KT702S(Satin) KT702M(Matt) KT702B(Black) KT702R(Rubber) KT702G(Golden)

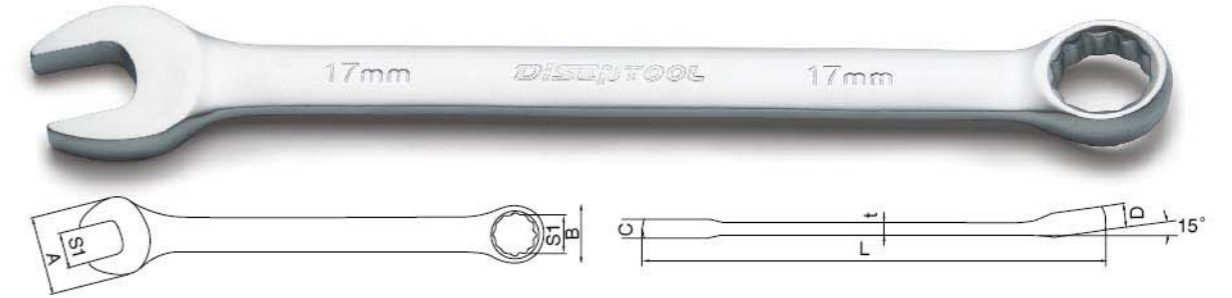

MM	SAE	A	B	S1	C	D	t	L	PCS	MEAS
6	1/4	13.5	10.8	6	4.1	4.9	2.9	111	300	360*140*140
7		15.3	12.3	7	4.6	5.3	3.2	121	300	360*140*140
8	5/16	18	13.8	8	5.1	6.3	3.3	132	300	375*160*155
9		18.6	15.6	9	5.4	6.7	3.6	142	300	375*160*155
10	3/8	21.2	16.4	10	5.7	6.7	3.7	152	250	395*180*155
11	7/16	23.3	18.4	11	6	6.8	3.9	162	250	395*180*155
12		25	19.4	12	6.1	6.9	4	173	250	415*200*170
13	1/2	26.4	20.8	13	6.2	7	4.1	183	250	415*200*170
14	9/16	30	22.6	14	6.8	8	4.3	193	150	260*220*225
15		31.4	23.4	15	6.9	8.4	4.5	203	150	260*220*225
16	5/8	33.5	23.6	16	7	8.4	4.6	213	100	285*235*175
17		35.7	26.3	17	7	8.6	4.6	224	100	285*235*175
18	11/16	38	28.2	18	7.4	9.3	4.8	233	100	300*253*190
19	3/4	39.4	29.1	19	7.5	9.4	4.9	244	100	300*253*190
20		41.5	31	20	8.1	10	5.4	254	60	290*275*165
21	13/16	42.5	31.9	21	8.2	10.1	5.5	264	60	290*275*165
22	7/8	45.3	33.4	22	8.2	10.8	5.6	274	60	290*275*165
23		47.1	36.4	23	8.7	12.3	6	284	60	310*300*170
24	15/16	48.4	36.6	24	8.9	11.4	6.2	293	60	310*300*170
25	1	51.4	38.4	25	9.1	11.6	6.3	306	60	350*315*190
26		51.4	38.4	26	9.1	11.6	6.3	306	60	350*315*190
27	1-1/16	54.3	40.3	27	9.7	12.8	6.5	334	30	355*240*135
28		56.7	42	28	10	13	6.7	349	30	385*258*145
29	1-1/8	56.7	42	29	10	13	6.7	349	30	385*258*145
30		59.3	44	30	11	14	7.2	381	30	420*276*150
32	1-1/4	63.1	47.4	32	11.1	14.9	7.9	403	30	420*276*150

### Stubby Combination Spanner 短柄两用扳手

Code:KT706(Mirror) KT706S(Satin) KT706M(Matt) KT706B(Black) KT706R(Rubber) KT706G(Golden)



MM	SAE	A	B	S1	C	D	t	L	PCS
8	5/16	17.08	13.2	8	5.3	6.6	3.6	93	480
9		19.2	14.6	9	5.5	6.9	3.7	96	480
10	3/8	21.3	16.3	10	5.6	7.5	3.8	101	480
11	7/16	22.4	18.4	11	5.6	8.1	3.8	106	480
12		24.7	19.5	12	6.4	8.4	4.4	109	240
13	1/2	26.6	21	13	6.5	8.5	4.5	116	240
14	9/16	28.55	22.1	14	6.6	9.5	4.6	118	180
15		28.9	24.2	15	7.2	9.9	4.9	122	180
16	5/8	32.9	25.3	16	7.5	10.5	5.2	126	180
17		34.6	26.85	17	7.8	11.1	5.5	133	180
18	11/16	36.6	28.7	18	8	11.4	5.7	138	120
19	3/4	37.5	30.4	19	8.1	11.7	5.9	142	120

## American Standard Combination Spanner 美标两用扳手

Code:KT705(Mirror) KT705S(Satin) KT705M(Matt) KT705B(Black) KT705R(Rubber) KT705G(Golden)

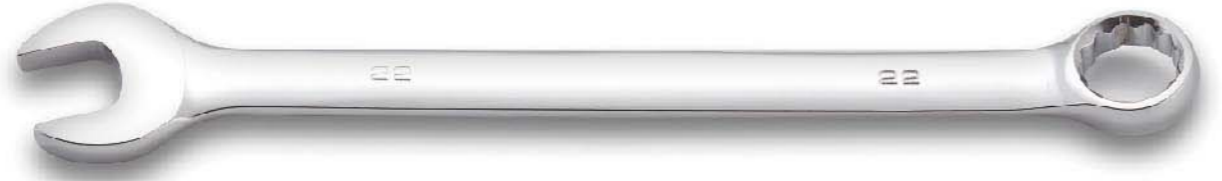

- .Made of Chrome Vanadium Steel / Carbon Steel
- .Hardened and Tempered
- .Three Layers Chrome Plated
- .Lifetime Warranty

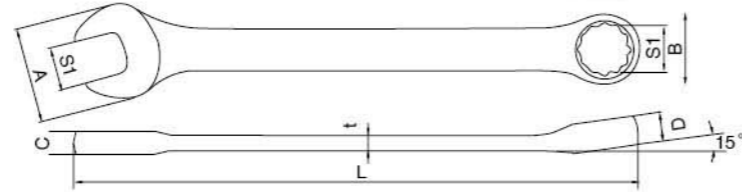

MM	SAE	A	B	S1	C	D	t	L	PCS	MEAS
6	1/4	14	12	6	4.3	6	3	130	480	345x165x180
7		14.5	13.2	7	4.6	6.4	3.2	135	480	345x165x180
8	5/16	17	14	8	5	6.8	3.4	141	480	405x175x220
9		19.5	15.8	9	5.6	7	3.6	152	360	465x190x195
10	3/8	21.2	16.2	10	5.7	7.4	3.8	163	360	465x190x195
11	7/16	22.7	18	11	6.2	7.6	4	168	360	525x200x230
12		25.5	19	12	6.4	8	4.2	174	360	525x210x230
13	1/2	27.5	21	13	6.3	8.5	4.3	180	240	355x210x230
14	9/16	29.5	21.8	14	6.8	9	4.4	194	240	395x235x240
15		31.8	23.5	15	6.8	9.8	4.5	204	180	300x235x240
16	5/8	33.5	24.5	16	6.8	10	4.6	210	180	300x235x240
17		34.8	26	17	7	10.5	4.8	229	120	300x265x175
18	11/16	37.4	27.5	18	7.3	11.4	5	240	120	330x275x195
19	3/4	39.5	28.8	19	7.8	11.6	5.2	253	120	330x285x195
20		42	29.8	20	8	12	5.4	270	80	300x230x215
21	13/16	43.9	31.6	21	8.2	12.5	5.6	283	80	310x240x215
22	7/8	46.2	33.6	22	8.4	13	5.8	298	60	325x240x165
23		48.7	35.6	23	8.6	13.5	6	312	60	335x225x215
24	15/16	50	37.2	24	8.8	15	6.2	322	60	350x225x235
25	1	53.6	39	25	9	15.5	6.3	343	60	370x240x235
26	1	53.6	39	26	9	15.5	6.3	343	60	370x240x235
27	1-1/16	57.5	41	27	9.4	16	6.5	367	30	400x240x145
28		61.1	43.4	28	9.8	16.3	6.7	384	30	400x240x145
29	1-1/8	63.2	44.6	29	10.6	16.5	7	405	30	400x240x145
30	1-3/16	63.2	44.6	30	10.6	16.5	7	405	30	435x255x155
32	1-1/4	66.9	46.7	32	11.4	17	7.5	429	30	455x255x165
34		71.9	50.8	34	11.9	17.5	8	452	30	480x175x175
36		74.7	55.8	36	14	17.1	8.5	482	20	500x195x185
38		78	57	38	14	17.6	10	504	20	500x195x185
41		90.9	66.3	41	14	22	10.3	540	20	530x290x125
46		86.4	66.8	46	14	18.7	10.6	535	20	595x345x115
50		96.5	74.8	50	16.2	25.3	12.2	602	10	635x370x120
55		100.8	78.8	55	16.3	24.8		617	5	655x185x130
60		112	83	60	18	27		660	5	685x635x140
65		119	88	65	20	27		682	5	685x635x140
70/75		135	103	70/75	26	36		720	3	755x150x190
80/85		155	115	80/85	26	40		750	3	855x170x115

### Available Finish

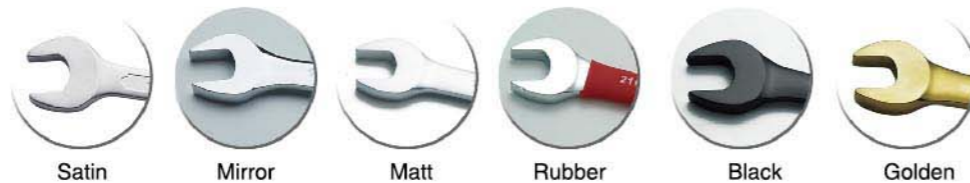

## DIN Combination Spanner 德标两用扳手

Code:KT704(Mirror) KT704S(Satin) KT704M(Matt) KT704B(Black)



- .Made of Chrome Vanadium Steel
- .Hardened and Tempered
- .Three Layers Chrome Plated/Satin Finish
- .Lifetime Warranty
- .Confirm to DIN 3113A .Anti Slip panel

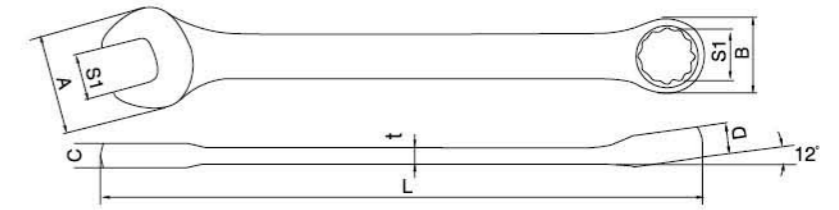

MM	A	B	S1	C	D	t	L	PCS	MEAS
6	6	10.8	6	4	5.3	2.8	110	300	375x140x145
7	7	12	7	4.2	5.8	2.9	120	300	375x140x145
8	8	13.2	8	4.5	6	3	130	300	375x160x155
9	9	14.6	9	4.8	6.5	3.2	141	300	375x160x155
10	10	16	10	5	7	3.4	150	300	390x165x175
11	11	17.3	11	5.2	7.5	3.6	161	250	395x180x155
12	12	18.6	12	5.4	8	3.8	171	250	415x200x170
13	13	20	13	5.6	8.8	4	181	250	415x200x170
14	14	21.4	14	5.9	9	4.2	191	150	260x220x225
15	15	22.8	15	6.2	9.8	4.4	201	150	260x220x225
16	16	24.2	16	6.5	10.3	4.6	211	100	285x235x175
17	17	25.6	17	6.8	10.5	4.8	221	100	285x235x175
18	18	27	18	7.1	11.3	5	231	100	295x260x190
19	19	28.4	19	7.4	11.5	5.2	241	100	295x260x190
20	20	29.8	20	7.6	12.3	5.4	251	60	290x275x165
21	21	31.2	21	7.8	12.5	5.6	261	60	290x275x165
22	22	32.6	22	8	12.5	5.8	271	60	290x275x165
23	23	34.4	23	8.2	13	6	281	60	310x300x170
24	24	35.4	24	8.5	13	6.2	291	60	310x300x170
25	25	36.8	25	8.8	13.8	6.4	302	60	330x315x190
26	26	38.2	26	9.1	14.3	6.6	312	60	330x315x190
27	27	39.6	27	9.4	14.5	6.8	321	30	240x350x135
28	28	41	28	9.7	15.3	7	331	30	240x350x135
29	29	42.4	29	10	15.5	7.2	341	30	385x258x145
30	30	43.8	30	10.3	16.3	7.4	351	30	385x258x145
32	32	46.6	32	10.8	17	7.8	371	20	385x258x145

### Different Stamping Patterns

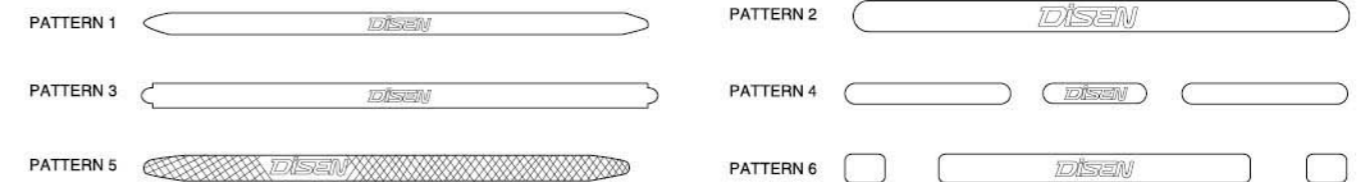

### Raised Panel Combination Spanner 凸筋两用扳手

Code:KT703(Mirror) KT703S(Satin) KT703B(Black)

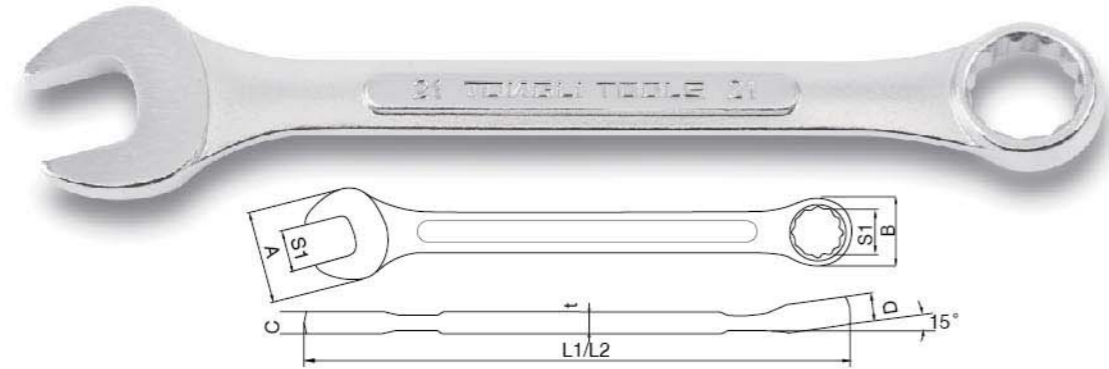

MM	A	B	S1	C	D	t	L1三代	L2厂标	PCS	MEAS
6	16	11.8	6	4.3	6.1	2.9	100	110	300	325x135x155
7	17.8	12.8	7	4.5	6.3	3.1	105	110	300	325x135x155
8	18.2	14	8	4.6	6.4	3.2	106	117	300	325x135x155
9	20.6	15.6	9	4.8	6.8	3.4	107	127	300	340x145x165
10	22	17	10	5	7.2	3.6	123	135	250	340x145x140
11	24	18.6	11	5.2	7.6	3.8	130	148	250	355x165x170
12	26.5	19.6	12	5.5	8.1	4.1	135	157	250	355x165x170
13	28	21	13	6.1	8.1	4.4	146	168	250	400x185x220
14	30	22	14	6.5	8.7	4.7	155	172	150	345x185x220
15	32	24	15	6.8	9.8	4.9	170	182	150	270x195x215
16	33.2	25	16	7.1	9.9	5.2	178	194	100	215x198x185
17	35.6	27	17	7.4	9.9	5.4	210	207	100	275x220x160
18	37.1	27.5	18	7.4	9.9	5.5	220	214	100	275x220x160
19	38.6	29.2	19	7.5	10	5.6	235	230	100	285x235x175
20	38.6	29.2	20	7.5	10	5.6	265	230	100	285x235x175
21	44	32	21	8.4	11	6.2	265	254	60	260x240x150
22	45.7	34	22	8.6	11.2	6.4	285	276	60	290x275x165
23	45.7	34	23	8.6	11.2	6.4	300	276	60	290x275x165
24	48.6	36.8	24	9.6	12	7.4	315	296	60	310x300x170
25	50.8	38.4	25	9.9	12.5	7.6	307	312	60	350x315x190
26	50.8	38.4	26	9.9	12.5	7.6	307	312	60	350x315x190
27	55	40	27	10.2	12.9	7.9	362	335	60	350x315x190
28	55	40	28	10.2	12.9	7.9	362	335	60	350x315x190
29	60	44.7	29	11.2	13.4	8.4	390	366	30	385x260x145
30	60	44.7	30	11.2	13.4	8.4	390	366	30	385x260x145
32	64.2	47.8	32	11.8	14.4	8.8	415	386	30	405x260x160
33	67	50	33	11	16	11	433	433	20	500x240x200
34	67	50	34	11	16	11	433	433	20	500x240x200
35	70	52	35	11	16	11	433	448	20	500x240x200
36	74	54	36	11.5	17	11.5	467	461	20	500x240x200
38	77.5	58	38	13	17.5	13	480	474	20	500x240x200
40	83.5	62	40	13.5	18	13.5	505	502	10	620x240x110
41	83.5	62	41	13.5	18	13.5	505	502	10	620x240x110
42	83.5	62	42	13.5	18	13.5	505	502	10	620x240x110
43	83.5	62	43	13.5	18	13.5	540	502	10	620x240x110
44	89	68	44	13.7	22	13.7	540	536	10	620x240x110
45	89	68	45	13.7	22	13.7	540	536	10	620x240x110
46	89	68	46	13.7	22	13.7	540	536	10	620x240x110
48	94	71	48	15	23	15	577	570	10	620x240x110
50	97	76	50	15.8	23	15.8	608	600	8	630x280x130
55	100	80	55	16	24	16	613	616	8	710x240x130
60	111	89	60	17.5	24	17.5	665	655	8	710x240x130
65	118	94	65	19	24	19	678	675	8	710x240x130

#### Available Finish



### Offset Combination Spanner 两用高颈扳手

Code:KT304(Mirror) KT304S(Satin) KT304M(Matt) KT304B(Black)



- .Made of Chrome Vanadium
- . Hardened and Tempered
- .Three Layers Chrome Plated/Satin Finish
- . Lifetime Warranty
- .Confirm to DIN 3113B
- .Anti Slip panel

MM	SAE	S	A1	A2	B1	B2	T	L	PCS	MEAS
6	1/4	6	3.5	4.9	15.1	10.3	2.5	100	300	335X135X140
7		7	3.6	5.6	17	11.9	2.6	110	300	335X135X140
8	5/16	8	4.8	6.3	17.5	13.9	3	120	300	370X150X155
9		9	5.4	6.8	19	15.4	3.6	130	300	375X160X155
10	3/8	10	5.7	7.3	22	16.6	3.8	155	300	465X185X200
11	7/16	11	6.2	7.8	24	18	4	162	300	465X185X200
12		12	6.4	8.3	26	19.6	4.2	170	250	495X205X165
13	1/2	13	6.6	8.8	28	21	4.3	178	250	495X205X165
14	9/16	14	6.8	9.3	30	22.2	4.4	192	250	560X220X190
15		15	7	9.9	32	23.6	4.5	210	150	345X245X255
16	5/8	16	7.2	10.3	34	25	4.6	220	150	345X245X255
17	11/16	17	6.7	11.3	38	27.6	5	226	100	315X250X240
18		18	6.7	11.3	38	27.6	5	226	100	315X250X240
19	3/4	19	8.6	11.8	40	29	5.2	246	100	310X275X245
20		20	8	12.9	41.5	30.4	5.4	262	60	355X305X175
21	13/16	21	8.2	13.4	43	31.8	5.6	272	60	355X305X175
22	7/8	22	8.4	13.9	45	33.2	5.8	277	60	355X305X175
23		23	8.8	14.9	50	36	6.2	323	60	360X345X195
24	15/16	24	8.8	14.9	50	36	6.2	323	60	360X345X195
25	1"	25	8.9	15.6	53.5	39	6.3	346	60	380X375X195
26		26	8.9	15.6	53.5	39	6.3	346	60	380X375X195
27	1.1/16	27	9.4	16.6	56.5	42	6.6	374	30	400X215X210
28	1.1/8	28	9.4	16.6	56.5	42	6.6	374	30	400X215X210
29		29	10.6	17.1	60	44	7	399	30	425X235X215
30	1.3/16	30	10.6	17.1	60	44	7	399	30	425X235X215
32	1.1/4	32	11.4	17.6	65	47	7.5	422	30	450X245X225

#### Different Stamping Patterns

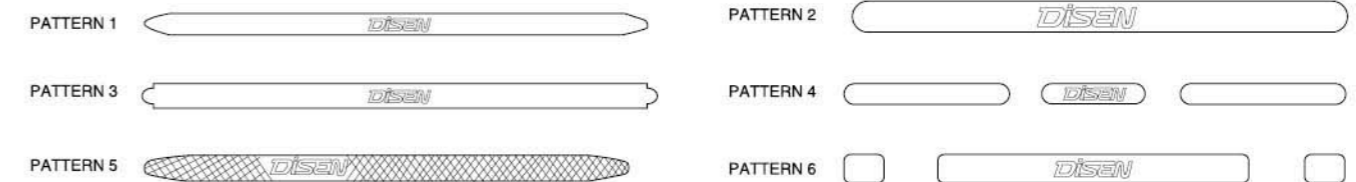

### Combination Spanner Bag Set 两用扳手挂袋套装



型号 METRIC SIZE	SIZE	mm	装箱数 Pcs	重量 Kg	体积 mm
6PCS:6mm-17mm	6,8,10,12,14,17mm		20	9	255x200x170
6PCS:8mm-19mm	8,10,12,14,17,19mm		20	11	255x200x170
8PCS:6mm-22mm	6,8,10,12,14,17,19,22mm		20	17.5	290x275x165
8PCS:8mm-24mm	8,10,12,14,17,19,22,24mm		20	23.5	310x300x170
10PCS:6mm-27mm	6,8,10,12,14,17,19,22,24,27mm		10	16	395x180x160
10PCS:8mm-24mm	8,10,12,13,14,15,17,19,22,24mm		10	13.5	315x215x145
12PCS:6mm-24mm	6,8,10,11,12,13,14,15,17,19,22,24mm		10	14.5	320x245x155
12PCS:6mm-32mm	6,8,10,12,14,17,19,22,24,27,30,32mm		10	18	420x280x175
12PCS:6mm-32mm	6,7,8,9,10,13,14,17,19,22,27,32mm		10	17	420x280x175
14PCS:6mm-24mm	6,7,8,9,10,11,12,13,14,15,17,19,22,24mm		10	18.5	330x275x160
14PCS:8mm-32mm	8,9,10,12,13,14,15,17,19,22,24,27,30,32mm		10	30	420x270x190
14PCS:8mm-24mm	8,9,10,11,12,13,14,15,17,18,19,21,22,24mm		10	18.5	330x275x160
14PCS:10mm-32mm	10,11,12,13,14,16,17,18,19,21,24,27,30,32mm		10	30.5	420x270x190
21PCS:6mm-27mm	6,7,8,9,10,11,12,13,14,15,16,17,18,19,20,21,22,23,24,25,27mm		5	17.5	495x190x155
24PCS:8mm-32mm	8,9,10,11,12,13,14,15,16,17,18,19,20,21,22,23,24,25,26,27,28,29,30,32mm		4	21	495x190x155
26PCS:6mm-32mm	6,7,8,9,10,11,12,13,14,15,16,17,18,19,20,21,22,23,24,25,26,27,28,29,30,32mm		4	23	540x200x140
14PCS:3/8-1x1/4	3/8,7/16,1/2,9/16,5/8,11/16,3/4,13/16,7/8,15/16,1,1x1/16,1x1/8,1x1/4		10	30.5	420x270x190

### Raised Panel Combination Spanner Bag Set 凸筋两用扳手挂袋组套

Code:KT703P(Mirror) KT703SP(Satin) KT703BP(Black)

型号 METRIC SIZE	SIZE	mm	装箱数 Pcs	重量 Kg	体积 mm
6PCS:6mm-17mm	6,8,10,12,14,17mm		20	9	255x200x170
8PCS:6mm-22mm	6,8,10,12,14,17,19,22mm		20	18.5	290x275x165
10PCS:6mm-24mm	6,8,10,12,14,17,19,22,24,27mm		10	17	395x180x160
12PCS:6mm-32mm	6,8,10,12,14,17,19,22,24,27,30,32mm		10	18	420x280x175
12PCS:6mm-24mm	6,8,10,11,12,13,14,15,17,19,22,24mm		10	14.5	320x245x155
14PCS:6mm-24mm	6,7,8,9,10,11,12,13,14,15,17,19,22,24mm		10	19	330x275x160
14PCS:8mm-24mm	8,9,10,11,12,13,14,15,17,18,19,21,22,24mm		10	19.5	330x275x160
10PCS:33mm-50mm	33,34,36,38,40,43,45,46,48,50mm		2	29.5	710x380x110
10PCS:1*5/16-2	1*5/16,1*3/8,1*7/16,1*1/2,1*5/8,1*11/16,1*3/4,1*13/16,1*7/8, 2"		2	29.5	710x380x110



·Made of Chrome Vanadium Steel / Carbon Steel  
·Hardened and Tempered  
·Three Layers Chrome Plated  
·Lifetime Warranty

### Combination Spanner Plastic Clip Set 两用扳手塑夹套装



型号 METRIC SIZE	SIZE	mm	装箱数 Pcs	重量 Kg	体积 mm
6PCS:6mm-17mm	6,8,10,12,14,17mm		30	15	478x470x160
8PCS:6mm-19mm	6,8,10,12,13,15,17,19mm		20	16	418x280x310
8PCS:6mm-22mm	6,8,10,12,14,17,19,22mm		20	20	640x415x175
10PCS:6mm-27mm	6,8,10,12,14,17,19,22,24,27mm		10	18.7	385x375x205
12PCS:6mm-24mm	6,8,10,11,12,13,14,15,17,19,22,24mm		10	16	410x315x210
12PCS:6mm-32mm	6,8,10,12,14,17,19,22,24,27,30,32mm		10	30	500x435x235
14PCS:6mm-24mm	6,7,8,9,10,11,12,13,14,15,17,19,22,24mm		5	8.5	300x210x240
16PCS:6mm-22mm	6,7,8,9,10,11,12,13,14,15,16,17,18,19,21,22mm		5	8	320x270x240
20PCS:6mm-27mm	6,7,8,9,10,11,12,13,14,15,16,17,18,19,20,21,22,23,24,27mm		5	15	360x235x275
22PCS:6mm-27mm	6,7,8,9,10,11,12,13,14,15,16,17,18,19,20,21,22,23,24,25,26,27mm		5	16	360x235x275

### Different Stamping Patterns

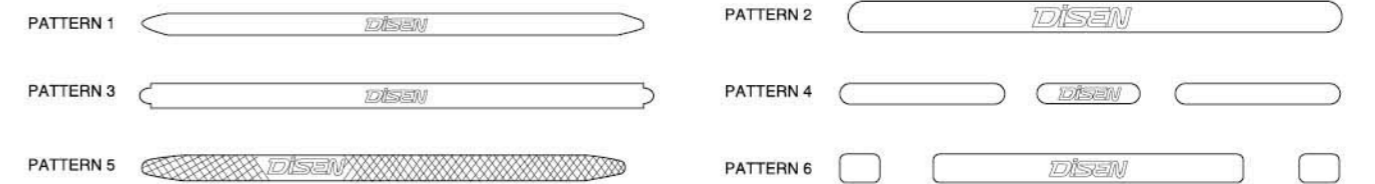

### Available Finish

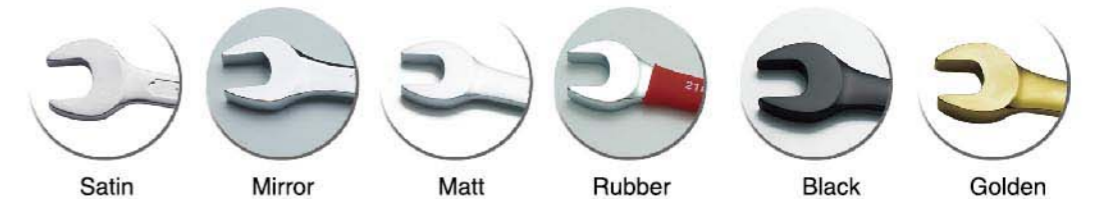

### Recessed Panel Double Open End Spanner 凹筋双头呆扳手

Code:KT501(Mirror) KT501S(Satin) KT501M(Matt) KT501B(Black) KT501R(Rubber) KT501G(Golden)



MM	SAE	A	B	S1	C	S2	t	L	PCS	MEAS
5.5-7		17.9	15.8	5.5	4.6	7	3.3	110	300	325x135x155
6-7	1/4x5/16	17.9	15.8	6	4.6	7	3.3	110	300	325x135x155
8-9	5/16x3/8	21.8	19	8	5	9	3.4	125	300	340x145x165
8-10		21.8	19	8	5	10	3.4	125	300	340x145x165
9-11		25.7	22.7	9	5.1	11	3.4	137	250	355x165x170
10-11	3/8x7/16	25.7	22.7	10	5.1	11	3.4	137	250	355x165x170
10-12		25.7	22.7	10	5.1	12	3.4	137	250	355x165x170
10-13		28.8	25.9	10	5.4	13	3.5	145	250	365x175x200
11-13		28.8	25.9	11	5.4	13	3.5	145	250	365x175x200
12-13	7/16x1/2	31.9	28	12	5.7	13	3.8	153	250	365x175x200
12-14		31.9	28	12	5.7	14	3.8	153	250	365x175x200
13-15		32.8	28	13	5.8	15	4	156	250	365x175x200
13-16		32.8	28	13	5.8	16	4	156	250	365x175x200
14-15	1/2x9/16	32.3	31.3	14	5.9	15	4.2	163	150	245x190x220
14-17		36.4	31.6	14	6.3	17	4.4	169	150	245x190x220
16-17	5/8x11/16	36.8	32.9	16	6.5	17	4.6	175	150	265x195x220
16-18		36.8	32.9	16	6.5	18	4.6	175	150	265x195x220
17-19		39.9	36.5	17	7	19	4.8	190	100	210x185x230
18-19		39.9	36.5	18	7	19	4.8	190	100	210x185x230
18-21		42.4	36.5	18	7.3	21	4.8	193	100	210x185x230
19-21		44.4	39.8	19	7.7	21	5.2	209	60	230x185x165
19-22		44.4	39.8	19	7.7	22	5.2	209	60	230x185x165
20-22	13/16x7/8	44.4	39.8	20	7.7	22	5.2	209	60	230x185x165
21-23	13/16x15/16	46.3	43.4	21	8.6	23	5.9	221	60	255x200x180
22-24		49.3	44.3	22	8.6	24	6.1	229	60	255x200x180
24-26		54.4	49.4	24	9	26	6.5	250	60	270x255x180
24-27	15/16x1.1/16	54.4	49.4	24	9	27	6.5	250	60	270x255x180
25-28	1x1.1/8	58	54.1	25	9.9	28	7.1	266	60	300x287x140
27-30		58	54.1	27	9.9	30	7.1	266	40	300x287x140
27-32		64	58	27	10.9	32	7.8	277	40	300x287x140
30-32	1.1/16x1.1/4	64	58	30	10.9	32	7.8	277	40	300x287x140
30-34		64	58	30	10.9	34	7.8	277	40	300x287x140
32-34		68.5	63.7	32	11.4	34	8	302	40	380x320x170
32-36		68.5	63.7	32	11.4	36	8	302	40	380x320x170
34-36		68.5	65.9	34	11.5	36	8.3	302	40	380x320x170
36-41		78.6	71.9	36	11.8	41	8.7	324	30	355x255x190
38-42		78.6	71.9	38	11.8	42	8.7	324	30	355x255x190
41-46		89.7	80	41	13.2	46	10.1	361	20	415x190x220
46-50		90.8	80.8	46	13.4	50	10.3	359	20	415x190x220
50-55		106.2	99.4	50	15.3	55	10.3	422	20	475x215x250

### American Standard Double Open End Spanner (C Type)

美标 (C款) 双头呆扳手

Code:KT506(Mirror)

- KT506S(Satin)
- KT506M(Matt)
- KT506B(Black)
- KT506R(Rubber)
- KT506G(Golden)

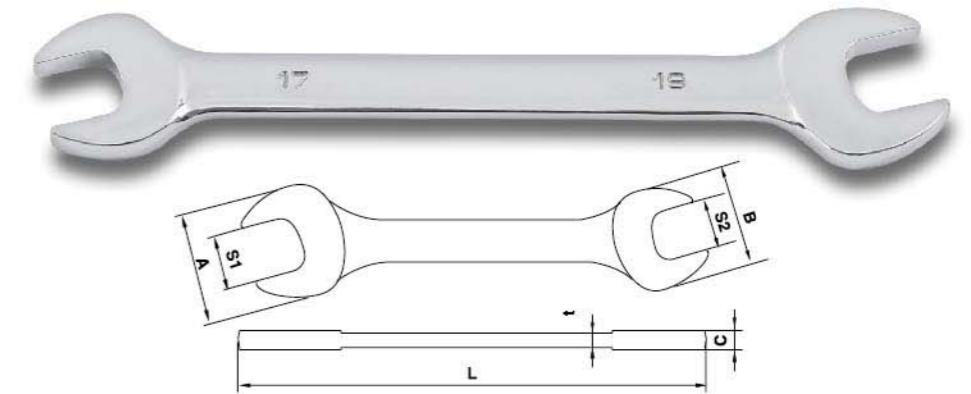

MM	A	B	S1	C	S2	t	L	PCS
5.5-7	14.4	16.3	5.5	4.9	7	3.1	125	400
6-7	14.4	16.3	6	4.9	7	3.1	125	400
8-10	18.2	22.2	8	5.5	10	3.8	144	400
9-11	22.2	26	9	5.5	11	4	161	400
10-12	22.2	26	10	6	12	4	161	300
11-13	26	30.8	11	6.5	13	4.4	182	300
12-14	26	30.8	12	6.5	14	4.4	182	200
13-15	30.8	36.3	13	7.2	15	4.8	198	200
13-16	30.8	36.3	13	7.2	16	4.8	198	200
14-17	30.8	36.3	14	7.2	17	4.8	198	200
16-18	30.8	36.3	16	8	18	5.3	198	100
17-19	36.3	39	17	8	19	5.3	219	100
18-21	44.8	38.5	18	8.5	21	6.1	242	100
19-21	44.8	38.5	19	8.5	21	6.1	242	100
19-22	44.8	38.5	19	8.5	22	6.1	242	100
21-23	44.2	48.6	21	9.8	23	6.8	263	100
22-24	44.2	48.6	22	9.8	24	6.8	263	100
24-27	48.6	56.2	24	10.5	27	7.6	289	60
27-30	61.6	65.7	27	11.4	30	7.9	298	40
30-32	61.6	65.7	30	11.4	32	7.9	312	40

### Different Stamping Patterns

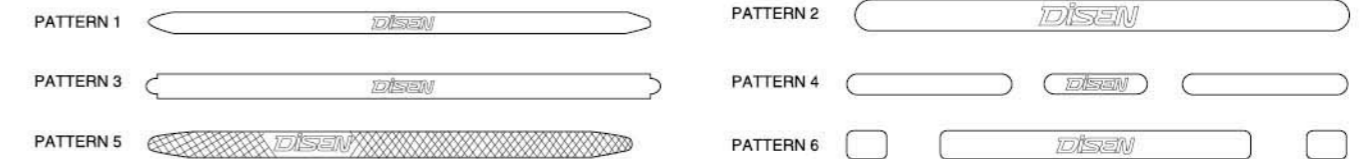

### Available Finish

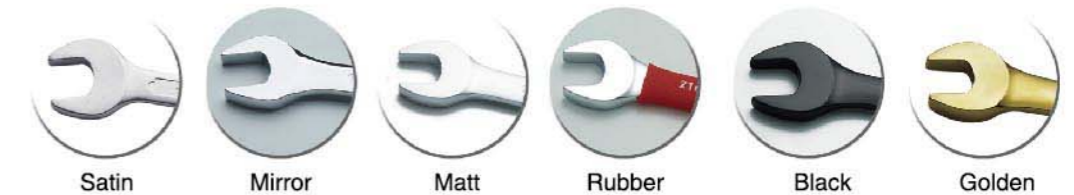

### American Standard Double Open End Spanner

美标双头开口扳手

Code:KT505(Mirror) KT505S(Satin) KT505M(Matt) KT505B(Black)

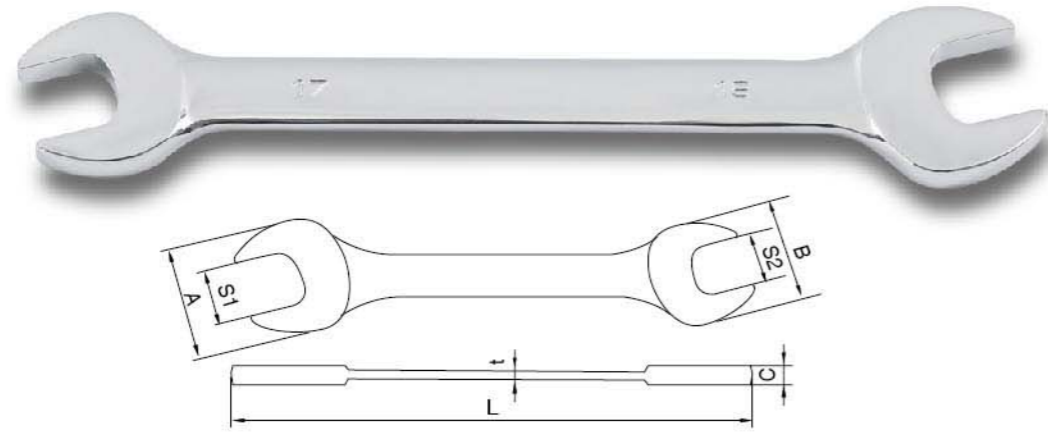

MM	A	B	S1	C	S2	t	L	PCS	MEAS
6*7	16.5	15	6	4.2	7	3	128	480	350x160x230
8*9	22.8	18.8	8	4.7	9	3.3	137	360	345x175x185
8*10	22.8	18.8	8	4.7	10	3.3	137	360	345x175x185
10*11	26.7	22.8	10	5.2	11	3.7	148	360	400x180x205
10*12	26.7	22.8	10	5.2	12	3.7	148	360	400x180x205
12*13	31.4	26.7	12	5.6	13	3.9	173	180	210x205x230
12*14	31.4	26.7	12	5.6	14	3.9	173	180	210x205x230
14*15	33.2	31.4	14	6.1	15	4.5	180	180	290x220x255
14*17	36.8	31.4	14	6.4	17	4.6	187	180	290x220x255
16*17	36.8	34.8	16	6.4	17	4.6	198	120	255x230x195
16*18	36.8	34.8	16	6.4	18	4.6	198	120	255x230x195
17*19	40.4	36.8	17	7.1	19	5.1	208	120	240x240x195
18*19	40.4	36.8	18	7.1	19	5.1	208	120	240x240x195
18*21	46.3	40.4	18	7.8	21	5.5	233	80	265x185x205
19*22	46.3	40.4	19	7.8	22	5.5	233	80	265x185x205
20*22	46.3	40.4	20	7.8	22	5.5	233	80	265x185x205
21*23	51.2	46.3	21	8.6	23	6.2	257	60	290x205x180
22*24	51.2	46.3	22	8.6	24	6.2	257	60	290x205x180
24*27	56.6	51.2	24	9.1	27	6.8	283	40	315x275x135
25*28	57.8	52.8	25	9.6	28	7.2	296	40	340x255x145
27*30	61.5	56.6	27	9.9	30	7.4	309	40	340x255x145
30*32	66	61.5	30	10.5	32	7.6	333	30	365x150x225

#### Available Finish

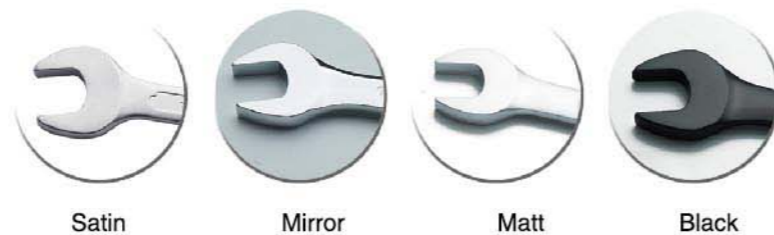

### DIN Double Open End Spanner 德标双头开口扳手

Code:KT504(Mirror) KT504S(Satin) KT504M(Matt) KT504B(Black)

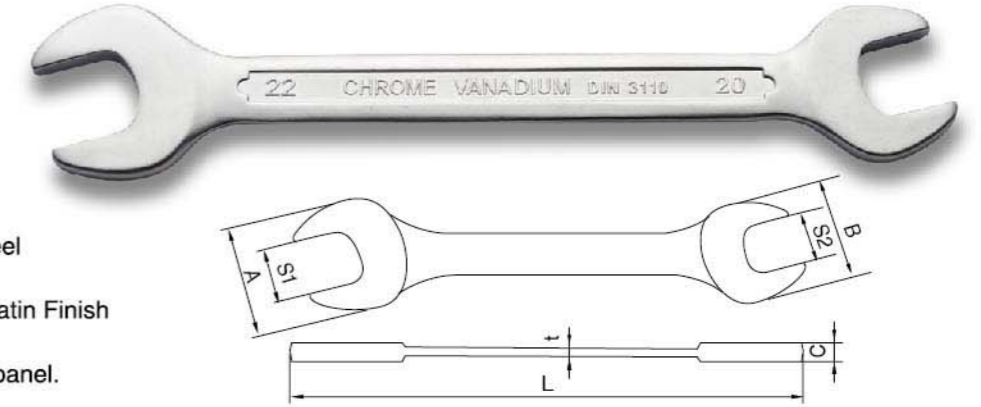

- .Made of Chrome Vanadium Steel
- .Hardened and Tempered
- .Three Layers Chrome Plated/Satin Finish
- .Lifetime Warranty
- .Confirm to DIN 3110 .Anti Slip panel.

MM	A	B	S1	C	S2	t	L	PCS	MEAS
6*7	17.5	15.4	6	3.7	7	2.9	120	300	265x140x135
8*9	22	19.5	8	4.1	9	3.2	139	300	290x160x155
8*10	22	19.5	8	4.4	10	3.5	139	300	290x160x155
9*11	26	23.5	9	4.7	11	3.8	155	250	340x180x160
10*11	26	23.5	10	4.7	11	3.8	155	250	340x180x160
10*12	26	23.5	10	4.7	12	3.8	155	250	340x180x160
10*13	28	25	10	5.2	13	4.1	170	200	260x190x170
11*13	28	25	11	5.2	13	4.1	170	200	260x190x170
12*13	30	27.5	12	5.2	13	4.1	170	200	260x190x170
12*14	30	27.5	12	5.2	14	4.1	170	200	260x190x170
14*15	34	32	14	5.7	15	4.4	185	150	225x215x210
13*17	37.5	32	13	6	17	4.6	189	150	225x215x210
14*17	37.5	32	14	6	17	4.6	189	150	225x215x210
16*17	38	35.3	16	6.2	17	4.7	200	150	225x215x210
16*18	38	35.3	16	6.2	18	4.7	200	150	225x215x210
17*19	42.2	39.5	17	6.7	19	5	220	100	240x170x230
18*19	42.2	39.5	18	6.7	19	5	220	100	240x170x230
19*21	48	43.5	19	7.2	21	5.4	235	60	260x180x170
19*22	48	43.5	19	7.2	22	5.4	235	60	260x180x170
20*22	48	43.5	20	7.2	22	5.4	235	60	260x180x170
21*22	50	45.8	21	7.7	22	5.7	245	60	260x180x170
21*23	50	45.8	21	7.7	23	5.7	245	60	260x180x170
21*24	52.5	47.8	21	8	24	5.8	250	60	275x190x190
22*24	52.5	47.8	22	8	24	5.8	250	60	275x190x190
24*26	57.5	52.5	24	8.2	26	5.9	260	60	275x190x190
24*27	57.5	52.5	24	8.2	27	5.9	260	60	275x190x190
25*28	59.5	54	25	8.6	28	6.1	270	40	295x220x145
27*30	64	57.5	27	9	30	6.4	279	40	295x220x145
30*32	67.7	64	30	9.2	32	6.7	294	40	315x235x155

#### Different Stamping Patterns

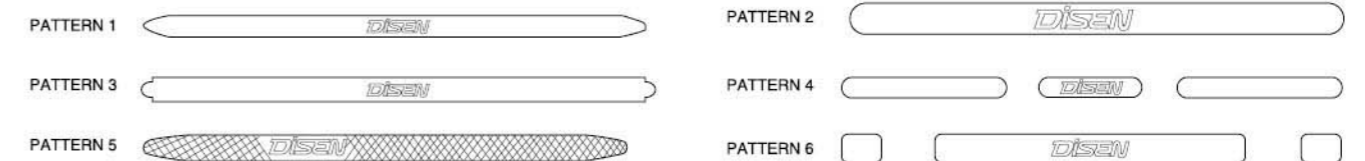

## Raised Panel Double Open End Spanner 双头凸筋呆扳手

Code:KT503(Mirror) KT503S(Satin) KT503B(Black)

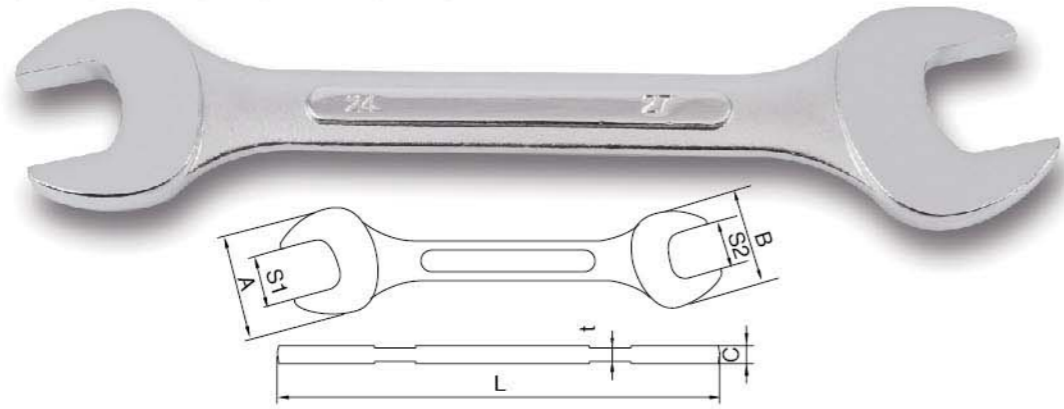

MM	A	B	S1	C	S2	t	L	PCS	MEAS
6*7	17.8	17	6	4.6	7	3	101	300	375x155x190
8*9	20.8	18.2	8	4.7	9	3.1	112	300	375x155x190
8*10	20.8	19.2	8	4.7	10	3.1	112	300	375x155x190
10*11	24.4	22	10	5.3	11	3.5	128	250	365x170x190
12*13	28	26.5	12	5.6	13	3.6	145	250	365x190x240
14*15	30	28	14	5.9	15	3.9	150	150	365x190x150
14*17	34	28	14	6.2	17	4.2	166	150	415x210x190
16*17	34	31	16	6.5	17	4.6	160	150	415x210x190
18*19	37.4	34	18	6.8	19	4.9	182	100	315x225x185
20*22	46.4	41.5	20	8.2	22	5.8	192	60	230x219x190
21*23	50.8	46.4	21	8.8	23	6.4	220	60	260x220x190
24*27	55.8	50.8	24	9.3	27	6.9	245	60	285x255x235
27*30	59	54	27	10	30	7.5	266	40	310x275x160
25*28	59	54	25	10	28	7.5	266	40	310x275x160
30*32	65	59	30	10.6	32	7.7	293	40	330x275x160

## Double Open End Spanner Bag Set 双头呆扳手挂袋套装

Code:KT501P(Mirror) KT501SP(Satin) KT501MP(Matt) KT501BP(Black) KT501RP(Rubber) KT501GP(Golden)

Code:KT501P(Mirror) KT501SP(Satin) KT501MP(Matt) KT501BP(Black) KT501RP(Rubber) KT501GP(Golden)

型号 METRIC SIZE	SIZE mm	装箱数 PCS	重量 Kg	体积 mm
6PCS:6mm-17mm	6x7,8x9,10x11,12x13,14x15,16x17mm	20	9	235x200x170
6PCS:8mm-19mm	8x9,10x11,12x13,14x15,16x17,18x19mm	20	9	255x200x170
8PCS:8mm-24mm	8x9,10x11,12x13,14x15,16x17,18x19,20x22,22x24mm	20	21.5	310x300x170
8PCS:6mm-22mm	6x7,8x9,10x11,12x13,14x15,16x17,18x19,20x22mm	20	17	290x260x295
10PCS:6mm-27mm	6x7,8x9,10x11,12x13,14x15,16x17,18x19,20x22,21x23,24x27mm	10	14	315x215x145
12PCS:6mm-32mm	6x7,8x9,10x11,12x13,14x15,16x17,18x19,20x22,21x23,24x27,25x28,30x32mm	10	23.5	310x300x170



## Double Open End Spanner Plastic Clip Set 双头呆扳手塑夹套装

Code:



Code:

KT501D(Mirror) KT501SD(Satin) KT501MD(Matt) KT501BD(Black) KT501RD(Rubber Coated) KT501GD(Golden) KT501E(Mirror) KT501SE(Satin) KT501ME(Matt) KT501BE(Black) KT501RE(Rubber) KT501GE(Golden)

- .Made of Chrome Vanadium Steel / Carbon Steel
- .Hardened and Tempered
- .Three Layers Chrome Plated
- .Lifetime Warranty

型号 METRIC SIZE	SIZE mm	装箱数 PCS	重量 Kg	体积 mm
6PCS:6mm-17mm	6x7,8x9,10x11,12x13,14x15,16x17mm	30	16	470x394x160
8PCS:6mm-22mm	6x7,8x9,10x11,12x13,14x15,16x17,18x19,20x22mm	20	18	415x420x175
10PCS:6mm-27mm	6x7,8x9,10x11,12x13,14x15,16x17,18x19,20x22,21x23,24x27mm	10	18	510x273x196
12PCS:6mm-32mm	6x7,8x9,10x11,12x13,14x15,16x17,18x19,20x22,21x23,24x27,25x28,30x32mm	10	24	450x305x220

### Available Finish

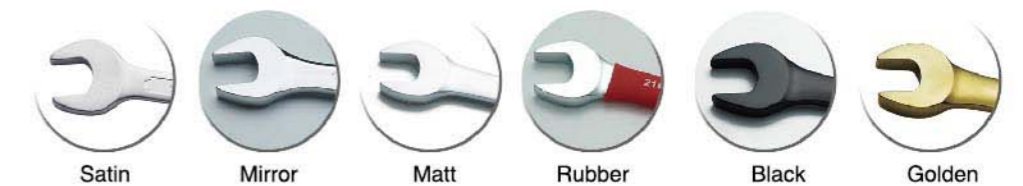

### Recessed Panel Double Offset Ring Spanner 凹筋双头梅花扳手

Code:KT601(Mirror) KT601S(Satin) KT601M(Matt) KT601B(Black) KT601R(Rubber) KT601G(Golden)  
 Code:KT602(Mirror) KT602S(Satin) KT602M(Matt) KT602B(Black) KT602R(Rubber) KT602G(Golden)



MM	SAE	A	B	S1	C	S2	D	t	L	PCS	MEAS
5.5-7		10.9	12.2	5.5	4.9	7	4.9	3.6	119	300	375x140x130
6-7	1/4x5/16	10.9	12.2	6	4.9	7	4.9	3.6	119	300	375x140x130
08-09	5/16x3/8	13.6	16.3	8	5.9	9	5.9	4.1	138	300	405x165x145
08-10		13.6	16.3	8	5.9	10	5.9	4.1	138	300	405x165x145
09-11		15.6	17.9	9	6.8	11	6.8	4.4	159	300	495x190x155
10-11	3/8x7/16	16.8	19.4	10	7.1	11	7.1	4.6	162	300	495x190x155
10-12		16.8	19.4	10	7.1	12	7.1	4.6	162	300	495x190x155
11-13		19.1	21.5	11	7.6	13	7.6	4.9	187	150	315x215x145
12-13	7/16x1/2	19.1	21.5	12	7.6	13	7.6	4.9	187	150	315x215x145
12-14		19.1	21.5	12	7.6	14	7.6	4.9	187	150	315x215x145
13-15		20.7	24.5	13	8.2	15	8.2	5	187	150	315x215x145
13-16		20.7	24.5	13	8.2	16	8.2	5	187	150	315x215x145
14-15	1/2x9/16	22.2	25	14	9.5	15	9.5	5.4	214	150	350x245x190
14-17		22.2	25.9	14	8.3	17	8.4	5.4	217	150	350x245x190
16-17	5/8x11/16	24.7	27.2	16	8.8	17	8.8	5.5	219	150	350x245x190
16-18		24.7	27.2	16	8.8	18	8.8	5.5	219	150	350x245x190
17-19		26.7	28.7	17	9.7	19	9.7	5.6	252	150	365x280x205
18-19		26.7	28.7	18	9.7	19	9.7	5.6	252	150	365x280x205
18-21		27.4	31.4	18	9.1	21	9.1	6.2	255	150	365x280x205
19-21		29.2	32.5	19	10.3	21	10.3	6.5	291	60	320x275x155
19-22		29.2	32.5	19	10.3	22	10.3	6.5	291	60	320x275x155
20-22	13/16x7/8	29.2	32.5	20	10.3	22	10.3	6.5	291	60	320x275x155
21-23	13/16x15/16	32.8	35.5	21	10.8	23	10.8	6.6	294	60	320x275x155
22-24		32.8	35.5	22	10.8	24	10.8	6.6	294	60	320x275x155
24-26		35.7	39.8	24	12.8	26	12.8	7.7	341	30	375x215x145
24-27	15/16x1.1/16	35.7	39.8	24	12.8	27	12.8	7.7	341	30	375x215x145
25-28	1x1.1/8	39.8	44.4	25	13.9	28	13.9	8.5	374	30	415x225x154
27-30		39.8	44.4	27	13.9	30	13.9	8.5	374	30	415x225x154
27-32		44.8	47.5	27	14.5	32	14.5	8.7	402	30	435x250x160
30-32	1.1/16x1.1/4	44.8	47.5	30	14.5	32	14.5	8.7	402	30	435x250x160
30-34		44.8	47.5	30	14.5	34	14.5	8.7	402	30	435x250x160
32-34		47.5	53.1	32	17	34	17	9.3	418	30	440x270x180
32-36		47.5	53.1	32	17	36	17	9.3	418	30	440x270x180
34-36		50.5	53.1	34	17	36	17	9.3	418	30	440x270x180
36-41		53.4	60.8	36	17.1	41	17.1	10.5	453	30	500x415x170
38-42		53.4	60.8	38	17.1	42	17.1	10.5	453	30	500x415x170
41-46		61.9	67.9	41	18.9	46	18.9	11.2	487	20	525x300x170
46-50		73.7	78.7	46	23.2	50	23.2	12	516	15	565x180x280
50-55		73.7	79	50	22.3	55	22.3	12.2	542	15	565x180x280

#### Available Finish

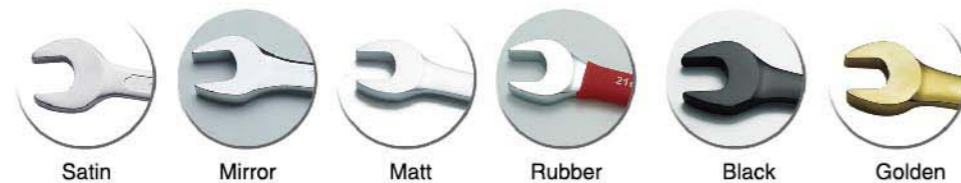

### American Standard Double Offset Ring Spanner 美标双头梅花扳手

Code:KT605(Mirror) KT605S(Satin) KT605M(Matt) KT605B(Black) KT605R(Rubber) KT605G(Golden)

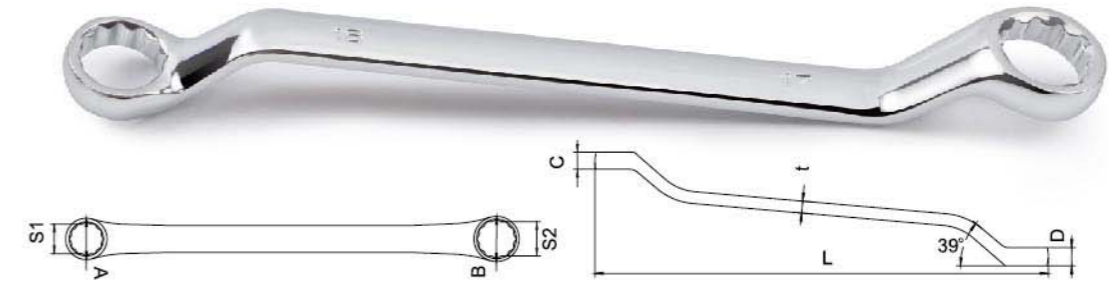

MM	A	B	S1	C	S2	D	t	L	PCS	MEAS
5.5x7	174.9	12.7	5.5	6.5	7	6	4.5	174	240	260x220x240
6x7	174.9	12.7	6	6.5	7	6	4.5	174	240	260x220x240
8x9	190.3	15	8	7	9	6.5	5	190	240	260x220x240
8x10	190.3	15	8	7	10	6.5	5	190	240	275x235x240
9x11	198.8	17.3	9	8	11	7.5	5.7	198	240	425x240x220
10x11	198.8	17.3	10	8	11	7.5	5.7	198	240	425x240x220
10x12	198.8	17.3	10	8	12	7.5	5.7	198	240	410x245x220
12x13	224.22	20.5	12	9	13	8.5	5.9	224	240	410x245x220
11x13	224.22	20.5	11	9	13	8.5	5.9	224	240	410x245x220
12x14	224.22	20.5	12	9	14	8.5	5.9	224	180	350x270x220
13x15	233.7	24	13	9.5	15	9	6	233	120	335x275x175
14x15	233.7	24	14	9.5	15	9	6	233	120	335x275x175
13x16	241.3	24	13	10	16	9.5	6.2	241	120	365x285x175
14x17	241.3	24	14	10	17	9.5	6.2	241	120	365x285x175
16x17	248.8	25.9	16	11	17	10.5	6.4	248	80	365x285x175
16x18	248.8	25.9	16	11	18	10.5	6.4	248	80	295x250x175
17x19	257	27.4	17	11.5	19	11	7	257	80	300x290x175
18x19	257	27.4	18	11.5	19	11	7	257	80	300x290x175
18x21	278.3	29.6	18	12.5	21	11.5	7.3	278	80	300x290x175
19x21	278.3	29.6	19	12.5	21	11.5	7.3	278	80	325x295x200
19x22	278.3	29.6	19	12.5	22	11.5	7.3	278	80	325x310x200
20x22	278.3	29.6	20	12.5	22	11.5	7.3	278	80	325x310x200
22x24	328.1	34	22	13.5	24	13	8	328	60	375x275x215
24x27	368.5	35.6	24	14	27	13.5	8.3	368	40	420x210x235
25x28	382.9	37.5	25	14.5	28	13.8	8.6	382	40	420x210x235
27x30	399.5	41	27	15	30	14	8.9	399	40	450x230x255
30x32	414.5	44.5	30	15.5	32	15	9.2	414	40	465x230x255

#### Different Stamping Patterns

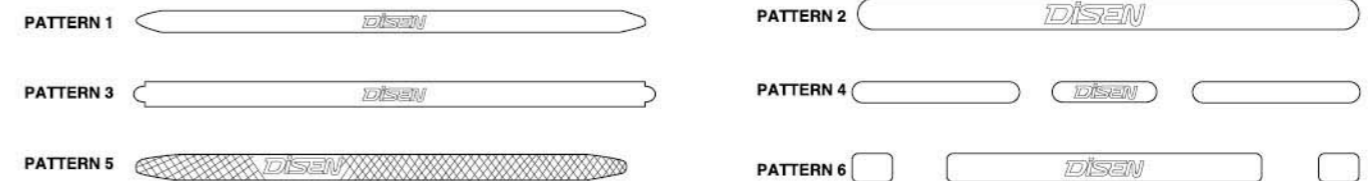

### American Standard Double Offset Ring Spanner (C Type)

美标C款双头梅花扳手



Code: KT606(Mirror)  
KT606S(Satin)  
KT606M(Matt)  
KT606B(Black)  
KT606R(Rubber)  
KT606G(Golden)

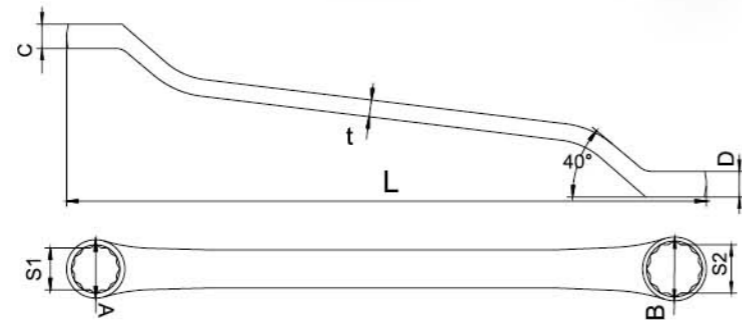

MM	A	B	S1	C	S2	D	t	L	PCS
5.5-7	11.5	12.5	5.5	6.2	7	6.5	4.5	158	400
6-7	11.5	12.5	5.5	6.2	7	6.5	4.5	158	400
8-10	14	16	8	7	10	7.2	4.8	173	400
9-11	14	16	8	7	10	7.2	4.8	173	300
10-12	16.7	19.5	10	8	12	8.5	5	190	300
11-13	16.7	19.5	10	8	12	8.5	5	190	200
12-14	19.5	22	12	8.5	14	9	5	203	200
13-15	19.5	22	12	8.5	14	9	5	203	150
13-16	19.5	22	12	8.5	14	9	5	203	150
14-17	23	26.6	14	9	17	9.9	5.5	231	150
16-18	23	26.6	14	9	17	9.9	5.5	231	150
17-19	26.5	28.7	17	10.7	19	10.7	6.5	247	100
18-21	26.5	28.7	17	10.7	19	10.7	6.5	247	80
19-21	26.5	28.7	17	10.7	19	10.7	6.5	247	80
19-22	29.5	33.5	19	10.7	22	11.2	6.8	266	80
21-23	29.5	33.5	19	10.7	22	11.2	6.8	266	60
22-24	33	36	22	11.6	24	13.2	8	311	60
23-26	33	36	22	11.6	24	13.2	8	311	40
24-27	36.8	40.7	24	13.1	27	13.7	8.5	357	40
27-30	42	45.8	27	14.5	30	15.1	9.5	381	40
30-32	45.5	48.8	30	14.5	32	15.5	9.5	402	30

#### Available Finish

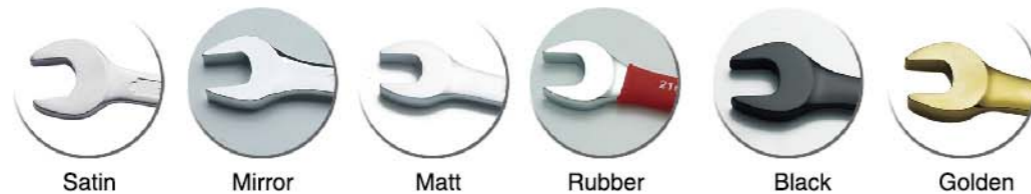

### DIN Double Offset Ring Spanner 德标梅花扳手

Code:KT604(Mirror) KT604S(Satin) KT604M(Matt) KT604B(Black) KT604R(Rubber)



.Made of Chrome Vanadium Steel  
. Hardened and Tempered  
. Three Layers Chrome Plated/Satin Finish  
. Lifetime Warranty  
. Confirm to DIN 838.Anti Slip panel.

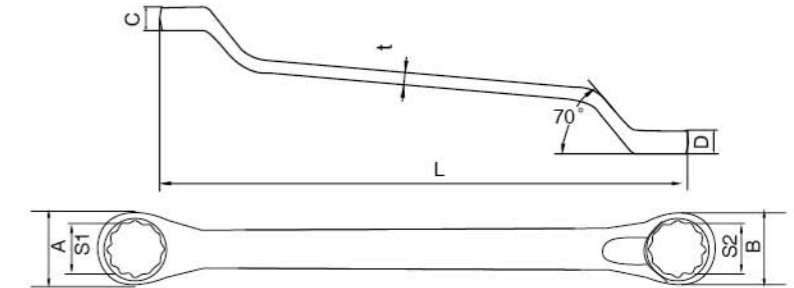

MM	A	B	S1	C	S2	D	t	L	PCS	MEAS
6*7	10.9	12.4	6	5.4	7	5.9	3.8	166	300	490x190x155
8*9	13.9	15.4	8	6.4	9	6.9	4.1	181	300	530x215x170
10*11	16.6	18	10	7.5	11	8	4.4	196	200	495x235x140
10*13	17	21	10	8.5	13	9	4.8	215	200	405x255x245
12*13	19.6	21	12	8.5	13	9	4.8	216	200	405x255x245
14*15	22.2	23.6	14	9.5	15	10	5.2	231	150	405x255x185
14*17	22.2	26.3	14	10	17	10.5	5.4	242	150	405x255x185
16*17	25	26.3	16	10.5	17	11	5.6	252	100	365x290x190
18*19	27.6	29	18	11.6	19	12.1	6	267	100	368x310x208
18*21	27.6	31.8	18	12.6	21	12.6	6.2	277	100	368x310x208
20*22	30.4	33.2	20	12.6	22	13.6	6.4	287	60	340x315x190
21*23	31.8	34.6	21	13.1	23	14.1	6.8	307	60	375x275x225
22*24	33.2	36	22	13.6	24	14.6	7	317	60	375x275x225
24*27	36	40.5	24	14.6	27	15.6	7.2	327	30	375x215x145
25*28	37.5	42	25	15.3	28	16.3	7.6	343	30	435x250x160
30*32	44	47	30	16.8	32	17.3	8.2	378	30	435x250x160

### DIN Double Offset Ring Spanner Bag Set

德标梅花扳手挂袋套装

Code:KT604P(Mirror) KT604SP(Satin) KT604MP(Matt) KT604BP(Black)



型号 METRIC SIZE	SIZE mm	装箱数 PCS	重量 Kg	体积 mm
6PCS:6mm-17mm	6x7,8x9,10x11,12x13,14x15,16x17mm	20	17.5	320x245x155
6PCS:8mm-19mm	8x9,10x11,12x13,14x15,16x17,18x19mm	20	18	320x245x155
8PCS:6mm-22mm	6x7,8x9,10x11,12x13,14x15,16x17,18x19,20x22mm	20	21	320x320x200
8PCS:8mm-24mm	8x9,10x11,12x13,14x15,16x17,18x19,20x22,22x24mm	20	26	360x245x250
10PCS:6mm-27mm	6x7,8x9,10x11,12x13,14x15,16x17,18x19,20x22,21x23,24x27mm	10	18	420x270x150
12PCS:6mm-32mm	6x7,8x9,10x11,12x13,14x15,16x17,18x19,20x22,21x23,24x27,25x28,30x32mm	10	31.5	415x370x190

## Deep Offset Ring Spanner 高颈梅花扳手

Code:KT603(Mirror) KT603S(Satin) KT603M(Matt) KT603B(Black) KT603R(Rubber) KT603G(Golden)

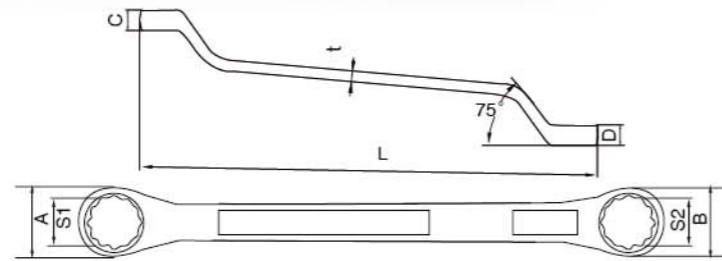

- .Made of Chrome Vanadium Steel / Carbon Steel
- .Hardened and Tempered
- .Three Layers Chrome Plated
- .Lifetime Warranty

MM	A	B	S1	C	S2	D	t	L	PCS	MEAS
6*7	11.8	13.3	6	6.4	7	6.4	4.6	163	300	490x190x155
8*9	14.5	15.7	8	7.4	9	7.4	5	180	300	530x215x170
8*10	14.5	15.7	8	7.4	10	7.4	5	180	300	530x215x170
10*11	17	18.7	10	9.2	11	9.2	5.8	199	200	495x235x140
10*12	17	18.7	10	9.2	12	9.2	5.8	199	200	495x235x140
12*13	20	21.5	12	9.5	13	9.5	7	224	200	405x255x245
12*14	20	21.5	12	9.5	14	9.5	7	224	200	405x255x185
14*15	23.2	24.7	14	11	15	11	7	230	150	405x255x185
14*17	26	27.2	14	11.2	17	11.2	7.6	260	100	365x290x190
16*17	26	27.2	16	11.2	17	11.2	7.6	260	100	365x290x190
17*19	28.8	30.4	17	12	19	12	8.1	291	100	368x210x208
18*19	28.8	30.4	18	12	19	12	8.1	291	100	368x310x208
20*22	32	35.2	20	13.6	22	13.6	8.6	305	60	340x315x190
21*23	34	37	21	14.7	23	14.7	9	338	60	375x275x225
22*24	34	37	22	14.7	24	14.7	9	338	60	375x275x225
24*27	37	40	24	16	27	16	9.2	351	30	375x215x145
25*28	39	42	25	16.5	28	16.5	9.5	372	30	435x250x160
27*30	41.2	44	27	17	30	17	9.8	388	30	435x250x160
27*32	41.2	44	27	17	32	17	9.8	388	30	435x250x160
30*32	45.2	47.5	30	17.5	32	17.5	10.2	404	30	435x250x160

### Available Finish

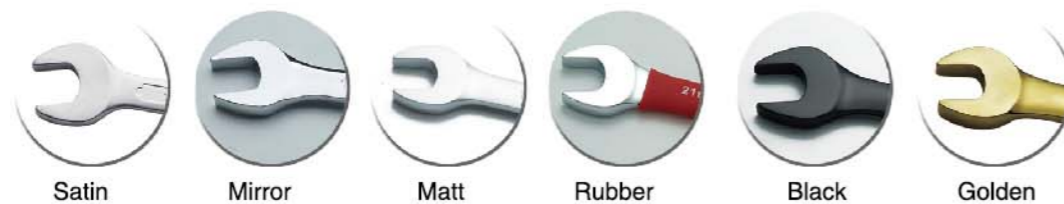

## Deep Offset Ring Spanner Bag Set 高颈梅花扳手挂袋套装

Code:KT603P(Mirror) KT603SP(Satin) KT603MP(Matt) KT603BP(Black) KT603RP(Rubber) KT603GP(Golden)

- .Made of Chrome Vanadium Steel / Carbon Steel
- .Hardened and Tempered
- .Three Layers Chrome Plated
- .Lifetime Warranty



型号 METRIC SIZE	SIZE mm	装箱数 PCS	重量 Kg	体积 mm
6PCS:6mm-17mm	6x7,8x9,10x11,12x13,14x15,16x17mm	20	12	380x270x145
6PCS:8mm-19mm	8x9,10x11,12x13,14x15,16x17,18x19mm	20	15.5	350x310x190
8PCS:6mm-22mm	6x7,8x9,10x11,12x13,14x15,16x17,18x19,20x22mm	20	19	370x280x200
8PCS:8mm-24mm	8x9,10x11,12x13,14x15,16x17,18x19,20x22,22x24mm	20	27.5	400x280x230
10PCS:6mm-27mm	6x7,8x9,10x11,12x13,14x15,16x17,18x19,20x22,21x23,24x27mm	10	17	370x280x200
12PCS:6mm-32mm	6x7,8x9,10x11,12x13,14x15,16x17,18x19,20x22,21x23,24x27,25x28,30x32mm	6	16	435x365x210

## Deep Offset Ring Spanner Plastic Holder Or Metal Clip Set 高颈梅花扳手塑架及铁夹套装

Code:KT603D(Mirror) KT603SD(Satin) KT603MD(Matt) KT603BD(Black) KT603RD(Rubber) KT603GD(Golden)  
Code:KT603E(Mirror) KT603SE(Satin) KT603ME(Matt) KT603BE(Black) KT603RE(Rubber) KT603GE(Golden)



型号 METRIC SIZE	SIZE mm	装箱数 PCS	重量 Kg	体积 mm
8PCS:6mm-22mm	6x7,8x9,10x11,12x13,14x15,16x17,18x19,20x22mm	20	30	640x415x175
8PCS:8mm-24mm	8x9,10x11,12x13,14x15,16x17,18x19,20x22,22x24mm	20	33	640x415x175

## Double Offset Ring Spanner Bag set

双头梅花扳手挂袋套装

Code:KT602P(Mirror) KT602SP(Satin) KT602MP(Matt) KT602BP(BlackP) KT602RP(Rubber) KT602GP(Golden)



型号 METRIC SIZE	SIZE mm	装箱数 PCS	重量 Kg	体积 mm
6PCS:6mm-17mm	6x7,8x9,10x11,12x13,14x15,16x17mm	20	17.5	320x245x155
6PCS:8mm-19mm	8x9,10x11,12x13,14x15,16x17,18x19mm	20	18	320x245x155
8PCS:6mm-22mm	6x7,8x9,10x11,12x13,14x15,16x17,18x19,20x22mm	20	21	320x320x200
8PCS:8mm-24mm	8x9,10x11,12x13,14x15,16x17,18x19,20x22,22x24mm	20	26	360x245x250
10PCS:6mm-27mm	6x7,8x9,10x11,12x13,14x15,16x17,18x19,20x22,21x23,24x27mm	10	18	420x270x150
12PCS:6mm-32mm	6x7,8x9,10x11,12x13,14x15,16x17,18x19,20x22,21x23,24x27,25x28,30x32mm	10	31.5	415x370x190

## Double Offset Ring Spanner Plastic Clip set

双头梅花扳手塑夹套装

Code:KT602D(Mirror) KT602SD(Satin) KT602MD(Matt) KT602BD(Black) KT602RD(Rubber) KT602GD(Golden)

- .Made of Chrome Vanadium Steel / Carbon Steel
- .Hardened and Tempered
- .Three Layers Chrome Plated
- .Lifetime Warranty



型号 METRIC SIZE	SIZE mm	装箱数 PCS	重量 Kg	体积 mm
6PCS:6mm-17mm	6x7,8x9,10x11,12x13,14x15,16x17mm	30	15	478x470x160
8PCS:6mm-22mm	6x7,8x9,10x11,12x13,14x15,16x17,18x19,20x22mm	20	21.5	640x415x175
10PCS:6mm-27mm	6x7,8x9,10x11,12x13,14x15,16x17,18x19,20x22,21x23,24x27mm	10	19.5	395x375x205
12PCS:6mm-32mm	6x7,8x9,10x11,12x13,14x15,16x17,18x19,20x22,21x23,24x27,25x28,30x32mm	10	32	500x435x230

## Ring Impact Wrench 敲击梅花扳手

MM	L	PCS	KG	MEAS
24	152	72	0.27	300x180x275
27	161	60	0.39	300x180x275
30	186	40	0.58	335x200x200
32	186	40	0.62	335x200x200
34	204	32	0.73	310x220x225
36	204	32	0.76	310x220x225
38	206	32	0.83	310x220x225
41	230	24	1.06	250x245x225
46	240	21	1.35	270x255x220
50	255	18	1.65	290x270x190
55	271	16	1.70	285x270x210
60	277	12	2.05	290x225x215
65	297	10	2.5	
70	333	6	3.4	
75	337	6	3.7	
80	342	6	3.9	
85	346	6	4.2	
90	375	5	5.3	
95	385	5	5.5	
100	400	4	6.4	
105	420	4	6.76	
110	436	4	7.2	
115	455	3	8.45	
120	475	3	8.8	
125	478	3	8.9	



## Ring Impact Wrench 敲击开口扳手

MM	L	PCS	KG
24	168	72	0.3
27	171	60	0.38
30	192	40	0.61
32	195	40	0.63
34	208	32	0.84
36	208	32	0.85
38	210	32	0.86
41	231	24	1.17
46	253	21	1.37
50	256	16	1.64
55	271	12	1.96
60	303	10	2.67
65	306	10	2.73
70	340	6	4.0
75	340	6	4.6
80	370	6	5.2
85	380	6	5.5
90	410	4	6.65
95	415	4	7.38
100	422	4	7.4
105	432	4	7.5
110	447	3	8.23
115	460	3	8.46
120	473	3	9.45
125	475	3	9.5



## Torque Adaptor 扭力适配器扳手

型号 METRIC SIZE	SIZE mm	装箱数 PCS	重量 Kg	体积 mm
9PCS:3/8-7/8	3/8, 7/16, 1/2, 9/16, 5/8, 11/16, 3/4, 13/16, 7/8	30	18.5	420x155x230



## Rear Wheel Camber Wrench Set

后轮外倾角扳手套组

型号 METRIC SIZE	SIZE mm	装箱数 PCS	重量 Kg
3PCS	FF 16x18 18-1/2	20	19.5





**3-jaw Puller(Drop Forged)** 单孔三爪拉马(锻压型)

Code:LM907

型号 METRIC SIZE	外箱尺寸 (mm)	只/箱 (PCS)	毛重 (KG)
75 ( 3" )	255x190x205	30	12.0
100( 4" )	360x300x220	40	21.2
150( 6" )	310x235x190	16	21.5
200( 8" )	380x250x210	16	32.4
250( 10" )	330x215x220	8	36.5
300( 12" )	365x230x215	6	27.2
350( 14" )	405x285x170	4	27.0
400( 16" )	450x170x290	3	26.6
500( 20" )	495x200x230	2	27.5
600( 24" )	525x210x245	2	31.4



**2-jaw Puller(Drop Forged)** 轴承二爪拉马(普通锻压 塑料包装袋)

Code:LM906

型号 METRIC SIZE	外箱尺寸 (mm)	只/箱 (PCS)	毛重 (KG)
65( 2" )	450x250x210	50	14
75( 3" )	450x250x210	50	17.5
100( 4" )	365x285x230	40	16
150( 6" )	345x335x225	30	18
200( 8" )	410x250x240	20	14.4



**Universal Wrench Series** 万能扳手



KT091



KT092



- .Made of Chrome Vanadium Steel / Carbon Steel
- .Hardened and Tempered
- .Three Layers Chrome Plated
- .Lifetime Warranty

货号 ITEM NO	SIZE	装箱数 PCS	重量 g	体积 mm
KT091	9-22 23-32	48	16.5	620x370x305
KT092	9-22 23-32	30	15.5	345x300x145

**8 in 1 Combination Wrench** 8合1组合套筒扳手

Code:KT1101

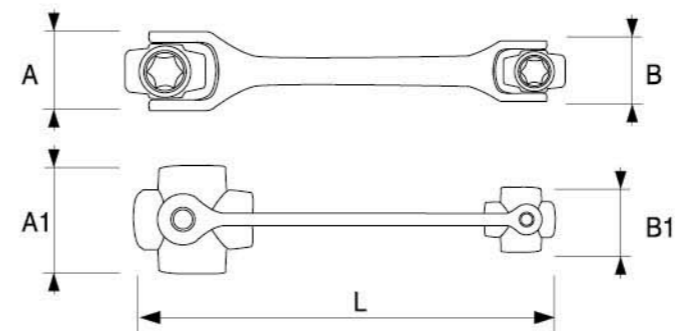

型号 METRIC SIZE	A mm	B mm	A1 mm	B1 mm	L mm
12-1 9mm	47	38	43	30	250
3/8"13/16"	47	38	43	30	250

- .Made of Chrome Vanadium steel /Carbon steel
- .Hardened and Tempered.Three layers Chrome Plated
- .Lifetime Warranty



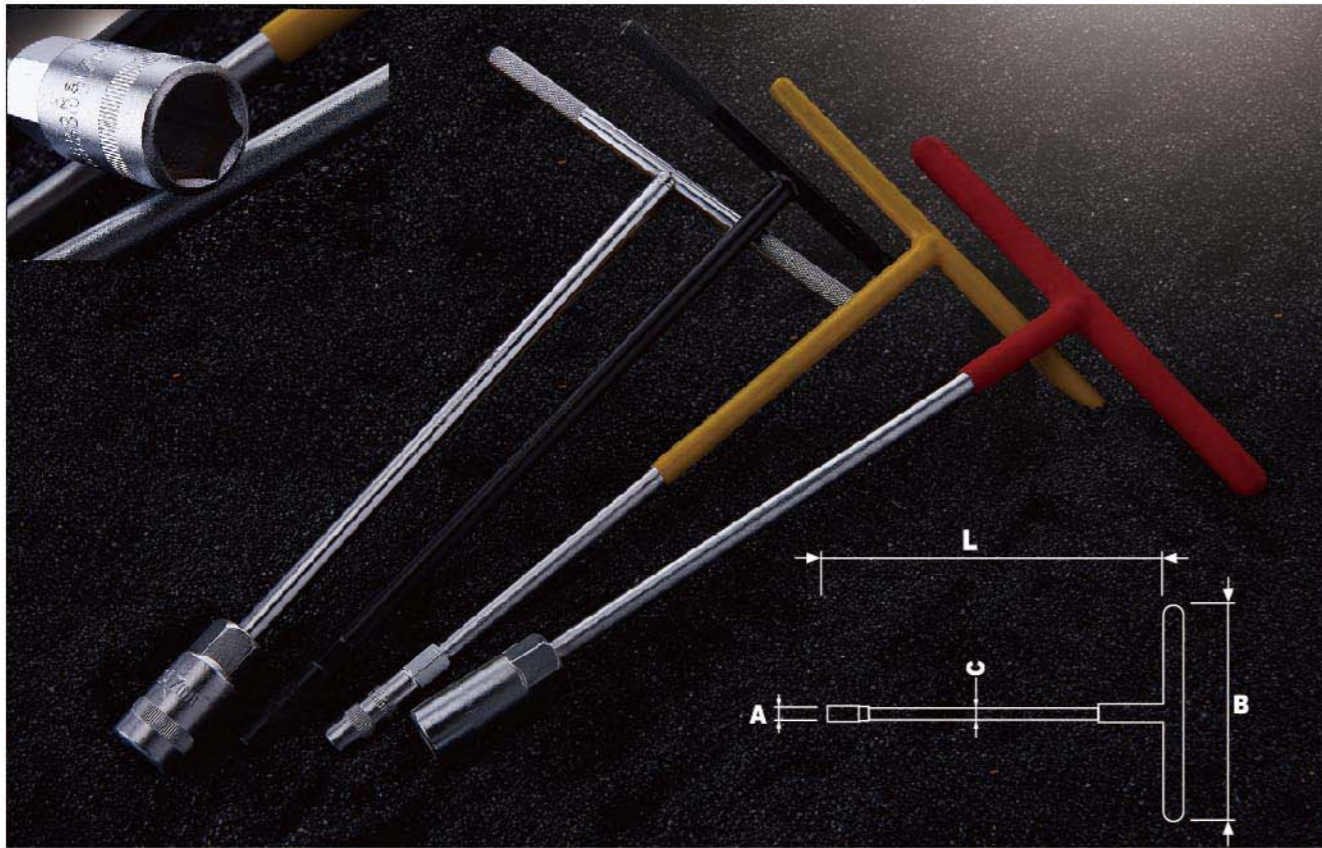

**T-Type Wrench** T型六角套筒扳手

Code:KT801S (Satin) KT801M(Mirror) KT801B(Black) KT801R(Rubber)

MM Sizes	Amm	Bmm	Cmm	Lmm	PCS	Kg	MEAS
6	11.5	190	8.5	298	100	24	360x360x160
7	12	190	8.5	298	100	24	360x360x160
8	12	190	8.5	298	100	24	360x360x160
9	14	190	8.5	298	100	24.5	360x360x160
10	14	190	8.5	298	100	24.5	360x360x160
11	18	190	8.5	298	100	28	360x360x160
12	18	190	8.5	298	100	28	360x360x160
13	20	190	8.5	298	100	29	360x360x160
14	20	190	8.5	298	100	29	360x360x160
15	20	190	9.5	298	80	32	360x360x160
16	24	190	9.5	298	80	37	360x360x160
17	24	190	9.5	298	80	37	360x360x160
18	26	190	9.5	298	80	38.5	360x360x160
19	26	190	9.5	298	80	38.5	360x360x160



**Magnetic Nut Socket** 磁性强力套筒

Code:KT802S (Satin) KT802M(Mirror) KT802B(Black)

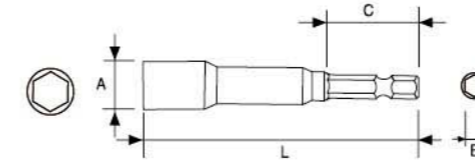

MM Sizes	Amm	Bmm	Cmm	Lmm	PCS	Kg	MEAS
5	10.5	6.35	25	65	500	16	335x215x280
5.5	11	6.35	25	65	500	16	335x215x280
6	11	6.35	25	65	500	16	335x215x280
7	13	6.35	25	65	500	18.8	335x215x280
8	13	6.35	25	65	500	18.8	335x215x280
9	14.5	6.35	25	65	500	20.5	335x225x430
10	14.5	6.35	25	65	500	20.5	335x225x430
11	16	6.35	25	65	500	24.5	335x225x430
12	17.5	6.35	25	65	500	27.5	335x225x430
13	17.5	6.35	25	65	500	27.5	335x225x430
14	20	6.35	25	65	500	27.5	335x225x430
15	21.5	6.35	25	65	250	15	335x215x295
16	24	6.35	25	65	250	19.5	335x215x295
17	24	6.35	25	100	250	19.5	335x215x295
18	25.2	6.35	25	100	250	21.3	335x215x295
19	26.2	6.35	25	100	250	21.3	335x215x295
5	10.5	6.35	25	100	500	22	335x255x280
5.5	11	6.35	25	100	500	22	335x255x280
6	11	6.35	25	100	500	22	335x255x280
7	13	6.35	25	100	500	25	335x255x280
8	13	6.35	25	100	500	25	335x255x280
9	14.5	6.35	25	100	500	26.5	550x250x230
10	14.5	6.35	25	100	500	26.5	550x250x230
11	16	6.35	25	100	500	30.5	550x250x230
12	17.5	6.35	25	100	500	33.5	550x250x230
13	17.5	6.35	25	100	500	33.5	550x250x230
14	20	6.35	25	100	500	33.5	550x250x230
15	21.5	6.35	25	100	250	19	335x255x275
16	24	6.35	25	100	250	23.5	335x255x275
17	24	6.35	25	100	250	23.5	335x255x275
18	25.2	6.35	25	100	250	24.5	335x255x275
19	26.2	6.35	25	100	250	24.5	335x255x275



**Y-Type Wrench** 三叉扳手

Code:KT803S (Satin) KT803M(Mirror) KT803B(Black)

MM Sizes	Amm	Bmm	Cmm	PCS	Kg	MEAS
8-10-12	8.5	8.5	8.5	100	28	360x360x160
10-12-14	8.5	8.5	8.5	60	17	360x360x200
12-14-17	9.5	9.5	9.5	60	26	360x360x200
14-17-19	9.5	9.5	9.5	60	26	360x360x200



# HEX KEY

## HIGH QUALITY

Hex key is our advantage product, which can meet the ANSI and DIN standard. Normally DISEN Hex key can be used permanently. DISEN Hex key can pass the VPA/GS approval and achieve the European Union and the United States environmental protection request, accurate diagonal to edge also allows DISEN tools can be in use more effort and freely.



### Short Hex Key 标准长内六角扳手单支

SIZE	PS/CTN	Length	G.W.	MEAS.
H1.5	700/8400	15*46	8.5	34*17.5*27
H2	600/7200	17.5*50.5	13.5	34*17.5*27
H2.5	300/3600	19*57	11.5	34*17.5*27
H3	150/4500	22*60	21.5	41.5*17*30
H4	84/2520	24.5*67.5	24	41.5*17*30
H5	50/1500	29*78	25.5	41.5*17*30
H6	40/960	32*88	27	33.5*30.5*20.5
H7	24/576	35*92	24	33.5*30.5*20.5
H8	24/576	39*99	31.5	33.5*30.5*20.5
H10	16/336	46.5*116	33.5	33*18*34
H12	12/180	53*128	28.5	33.5*18.5*26
H14	8/120	60*144	29.5	33.5*18.5*26
H16	6/72	75*157	26.5	37*22.5*18.5
H17	6/72	75*156	30.5	37*22.5*18.5
H18	4/48	75*153	22.5	37*22.5*18.5
H19	4/48	83*176	27.5	37*22.5*18.5
H20	4/32	83*177	21	37.8*29.5*18
H21	4/32	85*190	24.5	37.8*29.5*18
H22	4/32	88*205	28.5	37.8*29.5*18
H24	3/27	88*218	30.5	48*27.5*14
H27	2/18	92*227	27	48*27.5*14

SIZE	PS/CTN	Length	G.W.	MEAS.
H30	10	100*245	20.5	37*17.5*13
H32	8	120*284	22	39*20*14
H34	8	140*303	27	42*20*14
H36	6	100*258	18.5	42*18*14
H38	1	120*297	5	44*22.5*15
H40	1	110*271	5	47*24.5*16.5
H42	1	110*330	6	47*24.5*16.5



平头Flat Code: KTN2100(Mirror) KTN2100M(Matt) KTN2100B(Black) KTN2100Y(Yellow Nickel)  
球头Ball Code: KTN2101(Mirror) KTN2101M(Matt) KTN2101B(Black) KTN2101Y(Yellow Nickel)

### AVAILABLE FINISH

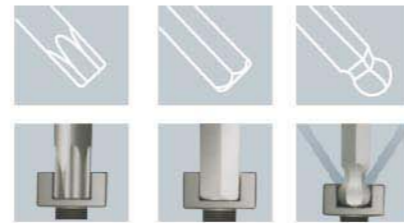
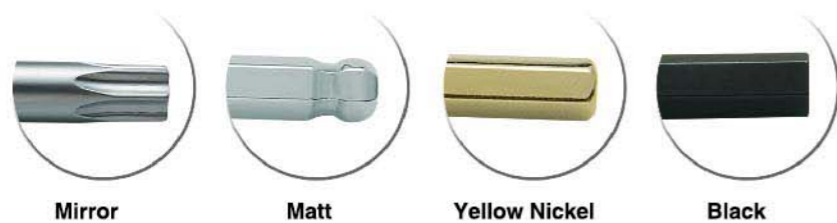

### Middle Long hex key 中长球头内六角扳手单支

SIZE	PS/CTN	Length	G.W.	MEAS.
H1.5	400/8400	16*79	7	35*14*23
H2	300/3600	19*85	9.5	35*15*20
H2.5	200/2400	20*93	11.5	31*17*20.5
H3	160/1920	23*102	14.5	31*17*20.5
H4	128/1536	27*113	22.5	25.5*20.5*21
H5	84/1008	31*126	25.5	23*22*20.5
H6	60/720	35*144	29.5	26*25*18.5
H8	20/400	40*160	32	38.5*26.5*14
H10	16/240	46*177	33.5	29.5*28*16.5
H12	12/120	55*188	26.5	24*24*20.5
H14	8/80	65*210	28	33*27.5*19
H16	4/48	75*246	26	32*29.5*17.5
H17	4/48	75*246	29	32*29.5*17.5
H18	4/40	80*270	30	34*23*19.5
H19	4/40	83*295	36	34*23*19.5

中长平头 Middle Long Flat Code:  
KTN2200(Mirror) KTN2200M(Matt) KTN2200H(Black) KTN2200Y(Yellow Nickel)  
中长球头 Middle Long Ball Code:  
KTN2201(Mirror) KTN2201M(Matt) KTN2201H(Black) KTN2201Y(Yellow Nickel)  
加长平头 Extra Long Flat Code:  
KTN2300(Mirror) KTN2300M(Matt) KTN2300H(Black) KTN2300Y(Yellow Nickel)  
加长球头 Extra Long Ball Code:  
KTN2301(Mirror) KTN2301M(Matt) KTN2301H(Black) KTN2301Y(Yellow Nickel)

### Extra Long hex key 加长球头内六角扳手单支

SIZE	PS/CTN	Length	G.W.	MEAS.
H1.5	400/8400	16*97	8	35*14*23
H2	300/3600	18*106	12	35*15*24.5
H2.5	200/2400	21*116	17.4	31*17*20.5
H3	160/1920	25*128	18	31*17*20.5
H4	112/1344	28*142	23.5	25.5*22.5*21
H5	84/840	34*157	26	24.5*16*25
H6	60/600	36*175	29.5	27.5*18*22.5
H7	20/320	39*186	25	30.5*20*21.5
H8	20/320	42*198	31.5	30.5*20*21.5
H10	16/224	50*225	39	33*20*22.5
H12	8/128	60*248	36.5	40*31*17
H14	6/60	70*271	27	31*21.5*19
H16	4/40	76*318	28	32.8*22*25
H17	4/40	76*303	29	32.8*22*25
H18	4/32	76*334	28	38.5*23*24
H19	4/32	83*346	32.5	38.5*23*24
H20	3/18	83*342	21	46*26.5*19
H21	3/18	83*368	25	46*26.5*19
H22	3/18	95*388	28.5	46*26.5*19
H24	2/12	105*431	25	46*26.5*19
H27	8	115*476	23.5	
H30	6	150*540	24.5	
H32	6	155*600	30.5	
H34	4	185*588	24	
H36	4	167*640	28	
H38	1	150*613	8	
H42	1	150*613	10	



### Torx key 六花星型扳手单支

标准短Short Code: KTN2400(Mirror) KTN2400M(Matt) KTN2400B(Black) KTN2400Y(Yellow Nickel)  
中长Long Code: KTN2500(Mirror) KTN2500M(Matt) KTN2500B(Black) KTN2500Y(Yellow Nickel)  
加长Extra Long Code: KTN2600(Mirror) KTN2600M(Matt) KTN2600B(Black) KTN2600Y(Yellow Nickel)

SIZE	Dia. (mm)	Short	Long	Extra long
T10	3	16*57	18*92	18*97
T15	3.3	17*62	21*98	20*106
T20	3.8	19*70	25*104	24*115
T27	4.3	21*77	27*110	28*126
T30	4.8	26*86	30*115	31*140
T40	5.5	29*96	31*125	31*162
T45	6.8	34*108	35*136	38*175
T45	7.8	38*123	38*146	42*197
T50	8.8	43*138	43*161	49*225

**METRIC:** 短平头 KTN-3100:9pcs Short Hex Key Set  
 中长平头 KTN-3101:9pcs Middle Long Hex Key Set  
 特长平头 KTN-3102:9pcs Extra Long Hex Key Set  
 短球头 KTN-3103:9pcs Short Ball Point Hex Key Set  
 中长球头 KTN-3104:9pcs Middle Long Ball Point Hex Key Set  
 特长球头 KTN-3105:9pcs Extra Long Ball Point Hex Key Set

**CONTAINS:** 1.5,2,2.5,3,4,5,6,8,10mm

**SAE:** 短平头 KTN-3106:9pcs Short Hex Key Set  
 中长平头 KTN-3107:9pcs Middle Long Hex Key Set  
 特长平头 KTN-3108:9pcs Extra Long Hex Key Set  
 短球头 KTN-3109:9pcs Short Ball Point Hex Key Set  
 中长球头 KTN-3110:9pcs Middle Long Ball Point Hex Key Set  
 特长球头 KTN-3111:9pcs Extra Long Ball Point Hex Key Set

**CONTAINS:** 1/16" , 5/64" , 3/32" , 1/8" , 5/32" , 3/16" , 1/4" , 5/16" , 3/8"

**TORX:** 短星型 KTN-3112: 9pcs Short Torx Key Set  
 中长星型 KTN-3113: 9pcs Middle Long Torx Key Set  
 特长星型 KTN-3114: 9pcs Extra Long Torx Key Set

**CONTAINS:** T10,T15,T20,T25,T27,T30,T40,T45,T50

**PACKING:** sliding card/blister & double blister



LENGTH	IN / OUT	G.W. / N.W.	MEAS.
标准短Short	12/72	24/23	73x35x22
中长Middle Long	12/60	25.5/23.5	62x35x27
加长Extra Long	12/60	30/28.5	62x35x32

**METRIC:** 短平头 KTN-3200:9pcs Short Hex Key Set  
 中长平头 KTN-3201:9pcs Middle Long Hex Key Set  
 特长平头 KTN-3202:9pcs Extra Long Hex Key Set  
 短球头 KTN-3203:9pcs Short Ball Point Hex Key Set  
 中长球头 KTN-3204:9pcs Middle Long Ball Point Hex Key Set  
 特长球头 KTN-3205:9pcs Extra Long Ball Point Hex Key Set

**CONTAINS:** 1.5,2,2.5,3,4,5,6,8,10mm

**SAE:** 短平头 KTN-3206:9pcs Short Hex Key Set  
 中长平头 KTN-3207:9pcs Middle Long Hex Key Set  
 特长平头 KTN-3208:9pcs Extra Long Hex Key Set  
 短球头 KTN-3209:9pcs Short Ball Point Hex Key Set  
 中长球头 KTN-3210:9pcs Middle Long Ball Point Hex Key Set  
 特长球头 KTN-3211:9pcs Extra Long Ball Point Hex Key Set

**CONTAINS:** 1/16" , 5/64" , 3/32" , 1/8" , 5/32" , 3/16" , 1/4" , 5/16" , 3/8"

**TORX:** 短星型 KTN-3212: 9pcs Short Torx Key Set  
 中长星型 KTN-3213: 9pcs Middle Long Torx Key Set  
 特长星型 KTN-3214: 9pcs Extra Long Torx Key Set

**CONTAINS:** T10,T15,T20,T25,T27,T30,T40,T45,T50

**PACKING:** sliding card/blister & double blister



LENGTH	IN / OUT	G.W. / N.W.	MEAS.
标准短Short	12/72	21/19.5	64X22.5X25.5
中长Middle Long	12/60	23.5/21.5	55.5X28.5X26
加长Extra Long	12/60	28.5/27	55.5X33X26

**METRIC:** 中长平头 KTN-3301:9pcs Middle Long Hex Key Set  
 特长平头 KTN-3302:9pcs Extra Long Hex Key Set  
 中长球头 KTN-3303:9pcs Middle Long Ball Point Hex Key Set  
 特长球头 KTN-3304:9pcs Extra Long Ball Point Hex Key Set

**CONTAINS:** 1.5,2,2.5,3,4,5,6,8,10mm

**SAE:** 中长平头 KTN-3305:9pcs Middle Long Hex Key Set  
 特长平头 KTN-3306:9pcs Extra Long Hex Key Set

中长球头 KTN-3307:9pcs Middle Long Ball Point Hex Key Set  
 特长球头 KTN-3308:9pcs Extra Long Ball Point Hex Key Set

**CONTAINS:** 1/16" , 5/64" , 3/32" , 1/8" , 5/32" , 3/16" , 1/4" , 5/16" , 3/8"

**TORX:** 中长平头 KTN-3309: 9pcs Middle Long Torx Key Set  
 特长平头 KTN-3310: 9pcs Extra Long Torx Key Set

**CONTAINS:** T10,T15,T20,T25,T27,T30,T40,T45,T50

**PACKING:** sliding card/blister

LENGTH	IN / OUT	G.W. / N.W.	MEAS.
中长Middle Long	12/60	24.5/22.5	61.5x47.5x17.5
加长Extra Long	12/60	29.5/28	64x52.5x18

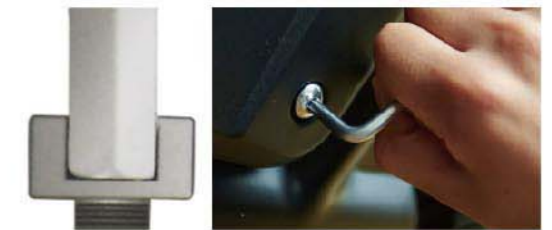

**METRIC:** 短平头 KTN-3400:9pcs Short Hex Key Set  
 中长平头 KTN-3401:9pcs Middle Long Hex Key Set  
 特长平头 KTN-3402:9pcs Extra Long Hex Key Set  
 短球头 KTN-3403:9pcs Short Ball Point Hex Key Set  
 中长球头 KTN-3404:9pcs Middle Long Ball Point Hex Key Set  
 特长球头 KTN-3405:9pcs Extra Long Ball Point Hex Key Set

**CONTAINS:** 1.5,2,2.5,3,4,5,6,8,10mm

**SAE:** 短平头 KTN-3406:9pcs Short Hex Key Set  
 中长平头 KTN-3407:9pcs Middle Long Hex Key Set  
 特长平头 KTN-3408:9pcs Extra Long Hex Key Set  
 短球头 KTN-3409:9pcs Short Ball Point Hex Key Set  
 中长球头 KTN-3410:9pcs Middle Long Ball Point Hex Key Set  
 特长球头 KTN-3411:9pcs Extra Long Ball Point Hex Key Set

**CONTAINS:** 1/16" , 5/64" , 3/32" , 1/8" , 5/32" , 3/16" , 1/4" , 5/16" , 3/8"

**TORX:** 短星型 KTN-3412: 9pcs Short Torx Key Set  
 中长星型 KTN-3413: 9pcs Middle Long Torx Key Set  
 特长星型 KTN-3414: 9pcs Extra Long Torx Key Set

**CONTAINS:** T10,T15,T20,T25,T27,T30,T40,T45,T50

**PACKING:** sliding card/blister & double blister

LENGTH	IN / OUT	G.W. / N.W.	MEAS.
标准短Short	12/72	22/21	68x33x22.5
中长Middle Long	12/60	24/22	57.8x33.5x27
加长Extra Long	12/60	28.5/27	58.5x31.5x34



**METRIC:** 短平头 KTN-3500:10pcs Short Hex Key Set  
 中长平头 KTN-3501:10pcs Middle Long Hex Key Set  
 特长平头 KTN-3502:10pcs Extra Long Hex Key Set  
 短球头 KTN-3503:10pcs Short Ball Point Hex Key Set  
 中长球头 KTN-3504:10pcs Middle Long Ball Point Hex Key Set  
 特长球头 KTN-3505:10pcs Extra Long Ball Point Hex Key Set

**CONTAINS:** 1.5,2,2.5,3,4,5,6,8,10,12mm

**SAE:** 短平头 KTN-3506:10pcs Short Hex Key Set  
 中长平头 KTN-3507:10pcs Middle Long Hex Key Set  
 特长平头 KTN-3508:10pcs Extra Long Hex Key Set  
 短球头 KTN-3509:10pcs Short Ball Point Hex Key Set  
 中长球头 KTN-3510:10pcs Middle Long Ball Point Hex Key Set  
 特长球头 KTN-3511:10pcs Extra Long Ball Point Hex Key Set

**CONTAINS:** 1/16" , 5/64" ,3/32" ,1/8" ,5/32" ,3/16" ,1/4" ,5/16" ,3/8" 7/16"

**TORX:** 短星型 KTN-3512: 10pcs Short Torx Key Set  
 中长星型 KTN-3513: 10pcs Middle Long Torx Key Set  
 特长星型 KTN-3514: 10pcs Extra Long Torx Key Set

**CONTAINS:** T10,T15,T20,T25,T27,T30,T40,T45,T50,T55

**PACKING:** sliding card/blister & double blister

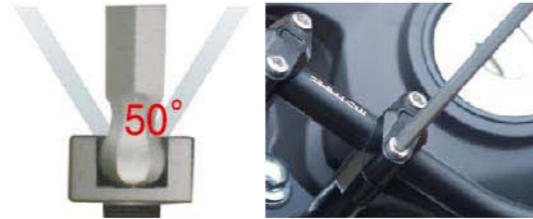

LENGTH	IN / OUT	G.W. / N.W.	MEAS.
标准短Short	12/36	23/21.5	41.5x25x22
中长Middle Long	12/36	24.5/22	41.5x30x22
加长Extra Long	12/36	27/24	41.5x34.5x22

**METRIC:** 短平头 KTN-3600:13pcs Short Hex Key Set  
 中长平头 KTN-3601:13pcs Middle Long Hex Key Set  
 特长平头 KTN-3602:13pcs Extra Long Hex Key Set  
 短球头 KTN-3603:13pcs Short Ball Point Hex Key Set  
 中长球头 KTN-3604:13pcs Middle Long Ball Point Hex Key Set  
 特长球头 KTN-3605:13pcs Extra Long Ball Point Hex Key Set

**CONTAINS:** 1.27,1.5,2,2.5,3,4,4.5,5,5.5,6,7,8,11mm

**SAE:** 短平头 KTN-3606:13pcs Short Hex Key Set  
 中长平头 KTN-3607:13pcs Middle Long Hex Key Set  
 特长平头 KTN-3608:13pcs Extra Long Hex Key Set  
 短球头 KTN-3609:13pcs Short Ball Point Hex Key Set  
 中长球头 KTN-3610:13pcs Middle Long Ball Point Hex Key Set  
 特长球头 KTN-3611:13pcs Extra Long Ball Point Hex Key Set

**CONTAINS:** 1/20,1/16,5/64,3/32,7/64,1/8,9/64,5/32,3/16,7/32,1/4,5/16,3/8

**PACKING:** sliding card/blister & double blister

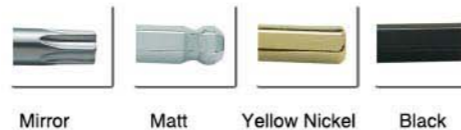

LENGTH	IN / OUT	G.W. / N.W.	MEAS.
标准短Short	12/48	22/17	44x30x20.5
中长Middle Long	12/48	25.5/20.5	54x30x20.5
加长Extra Long	12/48	31/25.5	62x30x20.5

**METRIC:** 中长平头星型 KTN-4601:18pcs Long Arm Hex Key And Torx Set  
 特长平头星型 KTN-4602:18pcs Extra Long Arm Hex Key And Torx Set  
 中长球头星型 KTN-4603:18pcs Long Arm Ball Point Hex Key And Torx Set  
 特长球头星型 KTN-4604:18pcs Extra Long Arm Ball Point Hex Key And Torx Set

**CONTAINS:** 1.5, 2, 2.5, 3, 4, 5, 6, 8, 10mm  
 T10, T15, T20, T25, T27, T30, T40, T45, T50

**PACKING:** double blister

LENGTH	IN / OUT	G.W. / N.W.	MEAS.
中长Long	6/30	26/23.5	78x34x26.5
加长Extra Long	6/30	31.5/28.5	78x38.5x27



**METRIC:** 短平头 KTN-4701:11pcs Short Arm Hex Key Set  
 中长平头 KTN-4702:11pcs Long Arm Hex Key Set  
 特长平头 KTN-4703:11pcs Extra Long Arm Hex Key Set  
 短球头 KTN-4704:11pcs Short Arm Ball Point Hex Key Set  
 中长球头 KTN-4705:11pcs Long Arm Ball Point Hex Key Set  
 特长球头 KTN-4706:11pcs Extra Long Arm Ball Point Hex Key Set

**CONTAINS:** 1.5, 2, 2.5, 3, 4, 5, 6, 8, 10, 12, 14mm

**PACKING:** sliding card/blister & double blister

LENGTH	IN / OUT	G.W. / N.W.	MEAS.
标准短Short	6/24	19/18	47x30x30
中长 Long	4/16	18/17	29x31x35
加长Extra Long	4/16	21/20	35.5x31x35



**METRIC:** 塑铁盒折叠平头内六角  
KTN-4601 : 8pcs Folding Hex Key Set  
塑铁盒折叠球头内六角  
KTN-4602 : 8pcs Folding Ball Point Hex Key Set  
**CONTAINS:** 1.5,2,2.5,3,4,5, 6,8mm

**SAE:** 塑铁盒折叠英制平头内六角  
KTN-4603 : 8pcs Folding Hex Key Set  
塑铁盒折叠英制球头内六角  
KTN-4604 : 8pcs Folding Ball Point Hex Key Set  
**CONTAINS:**1/16" ,5/64" ,3/32" ,1/8" ,5/32" ,3/16" ,7/32" ,1/4" ,5/16" ,3/8

**TORX:** 塑铁盒折叠星形内六角  
KTN-4605 : 8pcs Folding Torx Hex Key Set  
**CONTAINS:** T9,T10,T15,T20,T25,T27,T30,T40

**SAE:** 塑铁盒折叠平头内六角  
KTN-4606 : 9pcs Folding Hex Key Set  
**CONTAINS:**5/64" ,3/32" ,7/64" ,1/8" ,9/64" ,5/32" ,3/16" ,7/32" ,1/4"

**PACKING:** sliding card/blister & double blister



LENGTH	IN / OUT	G.W. / N.W.	MEAS.
Plastic Holder Folding 8pcs	8/64	18/17	52x45x38

**METRIC:** 铁盒折叠平头内六角  
KTN-4000:8pcs Metal Folding Hex Key set  
铁盒折叠球头内六角  
KTN-4001:8pcs Metal Folding Ball Point Hex Key set  
**CONTAINS:** 1.5,2,2.5,3,4,5,6,8mm

**SAE:** KTN-4002:8pcs Metal Folding Hex Key Set  
KTN-4003:8pcs Metal Folding Ball Point Hex Key Set  
**CONTAINS:** 1/16" ,5/64" ,3/32" ,1/8" ,5/32" ,3/16" ,1/4" ,5/16"

**TORX:** 铁盒折叠星形 KTN-4004: 8pcs Metal Folding Torx Key Set  
**CONTAINS:** T9,T10,T15,T20,T25,T27,T30,T40

**METRIC:** 塑架折叠星形KTN-4005:8pcs Folding Hex Key Set  
KTN-4006:8pcs Folding Ball Point Hex Key Set  
**CONTAINS:** 1.5,2,2.5,3,4,5,6,8mm

**SAE:** KTN-4007:8pcs Folding Hex Key Set  
KTN-4008:8pcs Folding Ball Point Hex Key Set  
**CONTAINS:** 1/16" ,5/64" ,3/32" ,1/8" ,5/32" ,3/16" ,1/4" ,5/16"

**TORX:** 塑架折叠星形KTN-4009: 8pcs Folding Torx Key Set  
**CONTAINS:** T9,T10,T15,T20,T25,T27,T30,T40

**PACKING:** sliding card/blister & double blister



ITEM	IN / OUT	G.W. / N.W.	MEAS.
Plastic 8PCS	12/96	15.5/14.5	45x41x28
Metal 8PCS	12/96	16.5/15.5	45x41x28

**METRIC:** 短两用内六角扳手  
KTN-4711:9pcs Short Combination Hex Key Set  
中长两用内六角扳手  
KTN-4712:9pcs Middle Long Combination Hex Key Set  
特长两用内六角扳手  
KTN-4713:9pcs Extra Long Combination Hex Key Set  
**CONTAINS:** 1.5-1.5 , 2-2 , 2.5-T10 , 3-T20 , 4-T27 , 5-T30 , 6-T40 , 8-T50 , 10-T55  
**PACKING:** sliding card/blister & double blister

LENGTH	IN / OUT	G.W. / N.W.	MEAS.
标准短Short	12/72	24/23	68x30x22
中长Middle Long	12/60	26/25	58x30x27
加长Extra Long	12/60	30/29	59x30x34



**METRIC:** 短平头 KTN-3400:9pcs Short Hex Key Set  
中长平头 KTN-3401:9pcs Middle Long Hex Key Set  
特长平头 KTN-3402:9pcs Extra Long Hex Key Set  
短球头 KTN-3403:9pcs Short Ball Point Hex Key Set  
中长球头 KTN-3404:9pcs Middle Long Ball Point Hex Key Set  
特长球头 KTN-3405:9pcs Extra Long Ball Point Hex Key Set

**CONTAINS:**1.5,2,2.5,3,4,5,6,8,10mm

**SAE:** 短平头 KTN-3406:9pcs Short Hex Key Set  
中长平头 KTN-3407:9pcs Middle Long Hex Key Set  
特长平头 KTN-3408:9pcs Extra Long Hex Key Set  
短球头 KTN-3409:9pcs Short Ball Point Hex Key Set  
中长球头 KTN-3410:9pcs Middle Long Ball Point Hex Key Set  
特长球头 KTN-3411:9pcs Extra Long Ball Point Hex Key Set

**CONTAINS:**1/16" ,5/64" ,3/32" ,1/8" ,5/32" ,3/16" ,1/4" ,5/16" ,3/8

**TORX:** 短星型 KTN-3412: 9pcs Short Torx Key Set  
中长星型 KTN-3413: 9pcs Middle Long Torx Key Set  
特长星型 KTN-3414: 9pcs Extra Long Torx Key Set

**CONTAINS:**T10,T15,T20,T25,T27,T30,T40,T45,T50

**PACKING:** sliding card/blister & double blister



LENGTH	IN / OUT	G.W. / N.W.	MEAS.
标准短Short	12/72	22/21	68x33x22.5
中长Middle Long	12/60	24/22	57.8x33.5x27
加长Extra Long	12/60	28.5/27	58.5x31.5x34

**METRIC:** 中长平头KTN-4301:10pcs Middle Long Hex Key Set  
特长平头KTN-4302:10pcs Extra Long Hex Key Set  
中长球头 KTN-4303:10pcs Middle Long Ball Point Hex Key Set  
特长球头KTN-4304:10pcs Extra Long Ball Point Hex Key Set

**CONTAINS:** 1.27,1.5,2,2.5,3,4,5, 6,8,10mm

**TORX:** 中长星型 KTN-4305: 9pcs Middle Long Torx Key Set  
特长星型 KTN-4306: 9pcs Extra Long Torx Key Set

**CONTAINS:** T10,T15,T20,T25,T27,T30,T40,T45,T50

**PACKING:** sliding card/blister & double blister



LENGTH	IN / OUT	G.W. / N.W.	MEAS.
中长Middle Long	12/60	23/22	60x30x32
加长Extra Long	12/60	27/26	60x35x32

**METRIC:** 短平头KTN-4401:13pcs Short Hex Key Set

中长平头KTN-4402:13pcs Middle Long Hex Key Set

特长平头KTN-4403:13pcs Extra Long Hex Key Set

短球头KTN-4404:13pcs Short Ball Point Hex Key Set

中长球头 KTN-4405:13pcs Middle Long Ball Point Hex Key Set

特长球头KTN-4406:13pcs Extra Long Ball Point Hex Key Set

**CONTAINS:** 2,2.5,3,4,5, 6,7, 8,10, 12, 14, 17, 19mm

**PACKING:** sliding card/blister & double blister



LENGTH	IN / OUT	G.W. / N.W.	MEAS.
标准短Short	3/12	22/21	40×30×35
中长Middle Long	2/8	21/20	40×39×24
加长Extra Long	2/8	25/24	44×40×24

**METRIC:** 短平头KTN-4501:12pcs Short Hex Key Set

中长平头KTN-4502:12pcs Middle Long Hex Key Set

特长平头KTN-4503:12pcs Extra Long Hex Key Set

短球头KTN-4504:12pcs Short Ball Point Hex Key Set

中长球头 KTN-4505:12pcs Middle Long Ball Point Hex Key Set

特长球头KTN-4506:12pcs Extra Long Ball Point Hex Key Set

**CONTAINS:** 1.5,2,2.5,3,4,5, 6,7,8,10,12,14mm

**PACKING:** sliding card/blister & double blister

LENGTH	IN / OUT	G.W. / N.W.	MEAS.
标准短Short	6/24	19/18	47×30×30
中长Middle Long	4/16	18/17	29×31×35
加长Extra Long	4/16	21/20	35.5×31×35

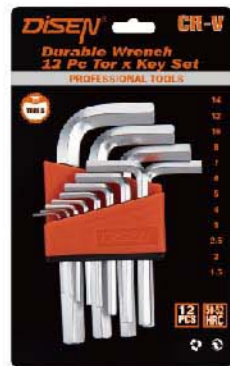

### T-handle hex key T型内六角扳手

**METRIC:** KTN-4300:2mm T-handle hex key KTN-4301:2.5mm T-handle hex key  
 KTN-4302:3mm T-handle hex key KTN-4303:4mm T-handle hex key  
 KTN-4304:5mm T-handle hex key KTN-4305:6mm T-handle hex key  
 KTN-4306:8mm T-handle hex key KTN-4307:10mm T-handle hex key

**METRIC:** KTN-4308:2mm Ball Point T-handle hex key  
 KTN-4309:2.5mm Ball Point T-handle hex key  
 KTN-4310:3mm Ball Point T-handle hex key  
 KTN-4311:4mm Ball Point T-handle hex key  
 KTN-4312:5mm Ball Point T-handle hex key  
 KTN-4313:6mm Ball Point T-handle hex key

KTN-4314:8mm Ball Point T-handle hex key  
 KTN-4315:10mm Ball Point T-handle hex key

SIZE	IN / OUT	G.W.	MEAS.
2mm	10/400	7.5	44×33×38
2.5mm	10/400	8.5	44×33×38
3mm	10/400	10	44×33×38
4mm	10/320	14.5	43×38×44
5mm	10/320	19	43×38×44
6mm	10/320	25	43×38×44
8mm	10/100	18.5	59×30×28
10mm	10/100	26	59×30×28



**METRIC:** T型平头内六角组套KTN-4701 : 7pcs T-handle hex key set

T型球头内六角组套KTN-4702 : 7pcs T-handle Ball Point hex key set

**CONTAINS:** 2,2.5,3,4,5, 6,8mm

**PACKING:** Double Blister

**TORX:** T型星形内六角组套KTN-4703 : 7pcs T-handle torx key set

**CONTAINS:** T10,T15,T20,T25,T30,T40,T45

**PACKING:** Double Blister

**METRIC:** T型平头内六角组套KTN-4704 : 8pcs T-handle hex key set

T型球头内六角组套KTN-4705 : 8pcs T-handle Ball Point hex key set

**CONTAINS:** 2,2.5,3,4,5, 6,8, 10mm

**PACKING:** PVC Pouch

**TORX:** T型星形内六角组套KTN-4706 : 8pcs T-handle torx key set

**CONTAINS:** T10,T15,T20,T25,T30,T40,T45, T50

**PACKING:** PVC Pouch

LENGTH	IN/OUT	G.W./N.W	MEAS.
Double Blister	6/36	20/19	56×37×47
PVC Pouch	6/36	25/24	62×32×34

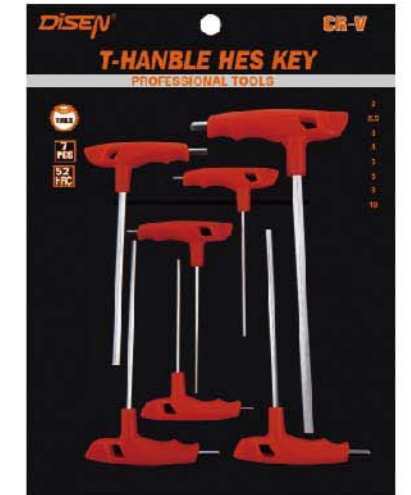

**METRIC:** KTN-4200:8pcs Short Hex Key Set

**CONTAINS:** 3,4,5,6,8,10,12,14mm

**METRIC:** KTN-4203:9pcs Short Hex Key Set

**CONTAINS:** 3,4,5,6,8,10,12,14,17mm

ITEM	PS/CTN	G.W.	MEAS.
8PCS	30	20.5	37×28×17
9PCS	20	22	37×20×17



# SOCKET SET

## 套筒系列



- .Made of Chrome Vanadium Steel / Carbon Steel
- .Hardened and Tempered
- .Three Layers Chrome Plated
- .Lifetime Warranty

### 3/8" DR 7PCS E SOCKET SET

**Code:DS-1003**

DESCRIPTION:  
 .6-E SOCKET E6-E8-E10-E11-E12-E14  
 .1-SLIDING T BAR



### 1/4" DR 6PCS E SOCKET SET

**Code:DS-1005**

DESCRIPTION:  
 .5-E SOCKET E4-E5-E6-E7-E8  
 .1-SLIDING T BAR



### 1/2" & 3/8" & 1/4" DR 17PCS E SOCKET SET

**Code:DS-1006**

DESCRIPTION:  
 .5-1/2" E SOCKET E16-E18-E20-E22-E24  
 .5-1/4" E SOCKET E4-E5-E6-E7-E8  
 .4-3/8" E SOCKET E10-E11-E12-E14  
 .1-1/4" SLIDING T BAR .1-3/8" SLIDING T BAR .1-1/2" SLIDING T BAR



### 1/2" DR 10PCS E SOCKET SET

**Code:DS-1007**

DESCRIPTION:  
 .9-E SOCKET E10-E11-E12-E14-E16-E18-E20-E22-E24MM  
 .1-SLIDING T BAR



**1/2" DR 10PCS SOCKET SET**

**Code:DS-1008**

DESCRIPTION:  
10-SOCKET 10-11-12-13-14-15-16-17-18-19MM  
1-METAL FRAME



**1/2" DR 10PCS SOCKET SET**

**Code:DS-2058**

DESCRIPTION:  
10-SOCKET 10-11-12-13-14-15-16-17-18-19MM  
1-METAL FRAME



**1/2" DR 12PCS SOCKET SET  
DS-2053**

DESCRIPTION:  
.10-1/2" DR SOCKET 10-11-12-13-14-17-19-21-22-24MM  
.1-1 DR QUICK RATCHET HANDLE 72T  
.1-1/2" DR EXTENSION BAR 5"  
.1-PLASTIC HANGER



**3/8" DR 12PCS SOCKET SET  
DS-2054**

DESCRIPTION:  
.10-3/8" DR SOCKET 10-11-12-13-14-15-17-19-22-24MM  
.1-1 DR QUICK RATCHET HANDLE 72T  
.1-3/8" DR EXTENSION BAR 6"  
.1-PLASTIC HANGER



**1/4" DR 12PCS SOCKET SET  
DS-2055**

DESCRIPTION:  
.10-1/4" DR SOCKET 4-5-6-7-8-9-10-11-12-13MM  
.1-1 DR QUICK RATCHET HANDLE 72T  
.1-1/4" DR EXTENSION BAR 6"  
.1-PLASTIC HANGER



**1/2" DR 20PCS SOCKET SET**

**Code:DS-1012**

DESCRIPTION:  
18-1/2" DR SOCKET 8-9-10-11-12-13-14-15-16-17-19-21-22-23-24-27-30-32MM  
1-1/2" DR RATCHET HANDLE 24T  
1-1/2" DR EXTENSION BAR 5"  
1-PLASTIC HANGER



**1/2" DR 11PCS SOCKET SET  
DS-1017**

DESCRIPTION:  
.10-1/2" DR SOCKET 10-11-12-13-14-17-18-19-21-22-24MM  
.1-1/2" DR RATCHET HANDLE 72T



**3/8" DR 11PCS SOCKET SET  
DS-1056**

DESCRIPTION:  
.10-3/8" DR SOCKET 10-11-12-14-17-19-21-22-24MM  
.1-1 DR QUICK RATCHET HANDLE 72T  
.1-PLASTIC HANGER



**1/4" DR 11PCS SOCKET SET  
DS-2056**

DESCRIPTION:  
.10-1/4" DR SOCKET 5-6-7-8-9-10-11-12-13-14MM  
.1-1 DR QUICK RATCHET HANDLE 72T  
.1-PLASTIC HANGER



## 29 PCS SOCKET SET

Code:DS-100029

- .12PCS-1/4" SOCKET  
4, 4.5, 5, 5.5, 6, 7, 8, 9, 10, 11, 12, 13
- .12PCS-1/4" BIT SOCKET
- .5PCS HEX 3, 4, 5, 6, 8
- .3PCS SL SL4, SL5.5, SL7
- .2PCS PH PH1, PH2
- .2PCS PZ PZ1, PZ2
- .1PC-1/4" RATCHET HANDLE
- .1PC-1/4" SPINNER HANDLE
- .1PC-1/4" SLIDING T BAR
- .1PC-1/4" EXTENSION BAR 50mm
- .1PC-1/4" UNIVERSAL JOINT



## 32 PCS SOCKET SET

Code:DS-100032

- .15PCS-1/2" SOCKET  
8, 10, 11, 12, 13, 14, 15, 17, 18, 19, 22, 24, 27, 30, 32
- .2PCS-1/2" SPARK PLUG SOCKET 16mm, 21mm
- .1PC-1/2" RATCHET HANDLE
- .2PCS-1/2" EXTENSION BAR 125mm, 250mm
- .1PC-1/2" UNIVERSAL JOINT
- .1PC-3/8"(F) x 1/2"(M) 3-WAY ADAPTOR
- .10PCS-COMBINATION WRENCH  
8, 9, 10, 11, 12, 13, 14, 17, 18, 19



## 56 PCS SOCKET SET

Code:DS-100056

- .13PCS-1/4" SOCKET  
4, 4.5, 5, 5.5, 6, 7, 8, 9, 10, 11, 12, 13, 14
- .4PCS-1/4" DEEP SOCKET 6, 7, 8, 10
- .6PCS-1/4" STAR SOCKET  
E4, E5, E6, E7, E8, E10
- .24PCS-1/4" BIT SOCKET
- .7PCS HEX 3, 4, 5, 6, 7, 8, 10
- .8PCS T  
T8, T10, T15, T20, T25, T27, T30, T40
- .3PCS SL SL4, SL5.5, SL6.5
- .3PCS PH PH1, PH2, PH3
- .3PCS PZ PZ1, PZ2, PZ3
- .1PC-1/4" RATCHET HANDLE
- .1PC-1/4" SPINNER HANDLE
- .2PCS-1/4" EXTENSION BAR 50mm, 100mm
- .1PC-1/4" UNIVERSAL JOINT
- .4PCS-HEX KEY WRENCH 1.5, 2, 2.5, 3



## 76 PCS SOCKET SET

- .10PCS-1/4" SOCKET 4, 5, 6, 7, 8, 9, 10, 11, 12, 13
- .5PCS-1/4" DEEP SOCKET 5, 6, 7, 8, 9
- .14PCS-1/4" BIT
- .7PCS T T10, T15, T20, T25, T27, T30, T40
- .4PCS SL SL3, SL4, SL5, SL6
- .3PCS PH PH1, PH2, PH3
- .1PC-1/4" RATCHET HANDLE
- .1PC-1/4" SPINNER HANDLE
- .1PC-1/4" EXTENSION BAR 50mm
- .1PC-1/4" UNIVERSAL JOINT
- .13PCS-1/2" SOCKET  
10, 11, 12, 13, 14, 15, 17, 19, 22, 24, 27, 30, 32
- .2PCS-1/2" SPARK PLUG SOCKET 16mm, 21mm
- .1PC-1/2" RATCHET HANDLE
- .2PCS-1/2" EXTENSION BAR 125mm, 250mm
- .1PC-1/2" UNIVERSAL JOINT
- .1PC-3/8"(F) x 1/2"(M) 3-WAY ADAPTOR
- .1PC-1/4" (F) x 1/4" (F) BIT HOLDER
- .6PCS-HEX KEY WRENCH 1.5, 2, 3, 5, 6, 7
- .8PCS-COMBINATION WRENCH 10, 11, 12, 13, 14, 15, 17, 19
- .3PCS-Screwdrivers(PH) PH2x38mm / PH2x100mm / PH3x200mm
- .2PCS-Screwdrivers(SL) SL6x100mm / SL6.5x38mm
- .1PC-COMBINATION PLIER
- .1PC-WATER PUMP PLIER
- .1PC-HAMMER



Code:DS-100076

## 82 PCS SOCKET SET

- .13PCS-1/4" SOCKET 4, 4.5, 5, 5.5, 6, 7, 8, 9, 10, 11, 12, 13, 14
- .17PCS-1/4" BIT SOCKET
- .4PCS HEX 3, 4, 5, 6
- .6PCS T T8, T10, T15, T20, T25, T30
- .3PCS SL SL4, SL5.5, SL7
- .2PCS PH PH1, PH2
- .2PCS PZ PZ1, PZ2
- .1PC-1/4" RATCHET HANDLE
- .1PC-1/4" SPINNER HANDLE
- .1PC-1/4" SLIDING T BAR
- .2PCS-1/4" EXTENSION BAR 50mm, 100mm
- .1PC-1/4" FLEXIBLE EXTENSION BAR
- .1PC-1/4" UNIVERSAL JOINT
- .15PCS-5/16" BIT
- .4PCS HEX 8, 10, 12, 14
- .4PCS T T40, T45, T50, T55
- .3PCS SL SL8, SL10, SL12
- .2PCS PH PH3, PH4
- .2PCS PZ PZ3, PZ4
- .12PCS-1/2" SOCKET 14, 15, 16, 17, 18, 19, 20, 21, 24, 27, 30, 32
- .2PCS-1/2" SPARK PLUG SOCKET 16mm, 21mm
- .1PC-1/2" RATCHET HANDLE
- .2PCS-1/2" EXTENSION BAR 125mm, 250mm
- .1PC-1/2" UNIVERSAL JOINT
- .1PC-3/8"(F) x 1/2"(M) 3-WAY ADAPTOR
- .1PC-1/4"HEX x 1/4" Sq (L25mm) BIT ADAPTOR
- .1PC-1/2" (F) x 5/16" (F) BIT HOLDER
- .9PCS-COMBINATION WRENCH 8, 10, 11, 12, 13, 14, 17, 19, 22



Code:DS-100082

### 88 (89) PCS SOCKET SET

- .9PCS-1/4" SOCKET 4, 5, 6, 7, 8, 9, 10, 11, 12
- .33PCS-1/4" BIT
- .5PCS HEX 2, 3, 4, 5, 6
- .8PCS T T8, T10, T15, T20, T25, T27, T30, T40
- .7PCS TT TT10, TT15, TT20, TT25, TT27, TT30, TT40
- .5PCS SL SL3, SL4, SL5, SL6.5
- .5PCS PH PH0, PH1, PH2, PH3
- .3PCS PZ PZ1, PZ2, PZ3
- .1PC-1/4" RATCHET HANDLE
- .1PC-1/4" SPINNER HANDLE
- .1PC-1/4" SLIDING T BAR
- .1PC-1/4" EXTENSION BAR 100mm
- .1PC-1/4" UNIVERSAL JOINT
- .13PCS-1/2" SOCKET 10, 11, 12, 13, 14, 15, 17, 19, 22, 24, 27, 30, 32
- .1PC-1/2" SPARK PLUG SOCKET 21mm
- .1PC-1/2" RATCHET HANDLE
- .2PCS-1/2" EXTENSION BAR 125mm, 250mm
- .1PC-1/2" UNIVERSAL JOINT
- .1PC-1/4" (F) x 1/4" (F) BIT HOLDER
- .8PCS-HEX KEY WRENCH 2, 2.5, 3, 4, 5, 6, 8, 10
- .4PCS-PIVOTED WRENCH 8x9, 10x11, 12x13, 14x15
- .11PCS-COMBINATION WRENCH 7, 8, 9, 10, 11, 12, 13, 14, 15, 17, 19



Code:DS-100088

### 94 PCS SOCKET SET

- .13PCS-1/4" SOCKET 4, 4.5, 5, 5.5, 6, 7, 8, 9, 10, 11, 12, 13, 14
- .8PCS-1/4" DEEP SOCKET 6, 7, 8, 9, 10, 11, 12, 13
- .17PCS-1/4" BIT SOCKET
- .4PCS HEX 3, 4, 5, 6
- .6PCS T T8, T10, T15, T20, T25, T30
- .3PCS SL SL4, SL5.5, SL7
- .2PCS PH PH1, PH2
- .2PCS PZ PZ1, PZ2
- .1PC-1/4" RATCHET HANDLE
- .1PC-1/4" SPINNER HANDLE
- .1PC-1/4" SLIDING T BAR
- .2PCS-1/4" EXTENSION BAR 50mm, 100mm
- .1PC-1/4" FLEXIBLE EXTENSION BAR
- .1PC-1/4" UNIVERSAL JOINT
- .15PCS-5/16" BIT
- .4PCS HEX 8, 10, 12, 14
- .4PCS T T40, T45, T50, T55
- .3PCS SL SL8, SL10, SL12
- .2PCS PH PH3, PH4
- .2PCS PZ PZ3, PZ4
- .18PCS-1/2" SOCKET
- 10,11,12,13,14,15, 16,17,18,19,20,21,22,23,24,27,30,32
- .4PCS-1/2" DEEP SOCKET 14, 15, 17, 19
- .2PCS-1/2" SPARK PLUG SOCKET 16mm, 21mm
- .1PC-1/2" RATCHET HANDLE
- .2PCS-1/2" EXTENSION BAR 125mm, 250mm
- .1PC-1/2" UNIVERSAL JOINT
- .1PC-3/8"(F) x 1/2"(M) 3-WAY ADAPTOR
- .1PC-1/4"HEX x 1/4" Sq (L25mm) BIT ADAPTOR
- .1PC-1/2" (F) x 5/16" (F) BIT HOLDER
- .3PCS-HEX KEY WRENCH 1.5, 2, 2.5



Code:DS-100094

### 108 PCS SOCKET SET

- .13PCS-1/4" SOCKET 4, 4.5, 5, 5.5, 6, 7, 8, 9, 10, 11, 12, 13, 14
- .8PCS-1/4" DEEP SOCKET 6,7,8,9,10,11,12,13
- .5PCS-1/4" STAR SOCKET E4, E5, E6, E7, E8
- .18PCS-1/4" BIT SOCKET
- .4PCS HEX 3, 4, 5, 6
- .7PCS T T8, T10, T15, T20, T25, T27, T30
- .3PCS SL SL4, SL5.5, SL6.5
- .2PCS PH PH1, PH2
- .2PCS PZ PZ1, PZ2
- .1PC-1/4" RATCHET HANDLE
- .1PC-1/4" SPINNER HANDLE
- .1PC-1/4" SLIDING T BAR
- .2PCS-1/4" EXTENSION BAR 50mm, 100mm
- .1PC-1/4" UNIVERSAL JOINT
- .17PCS-5/16" BIT
- .5PCS HEX 7, 8, 10, 12, 14
- .5PCS T T40, T45, T50, T55, T60
- .3PCS SL SL8, SL10, SL12
- .2PCS PH PH3, PH4
- .2PCS PZ PZ3, PZ4
- .17PCS-1/2" SOCKET
- 10,11,12,13,14,15, 16,17,18,19,20,21,22, 24,27,30,32
- .5PCS-1/2" DEEP SOCKET 14,15,17,19, 22
- .8PCS-1/2" STAR SOCKET
- E10, E11, E12, E14, E16, E18, E20, E24
- .2PCS-1/2" SPARK PLUG SOCKET 16mm, 21mm



Code:DS-100108

- .1PC-1/2" RATCHET HANDLE
- .2PCS-1/2" EXTENSION BAR 125mm, 250mm
- .1PC-1/2" UNIVERSAL JOINT
- .1PC-3/8"(F) x 1/2"(M) 3-WAY ADAPTOR
- .1PC-1/2" (F) x 5/16" (F) BIT HOLDER
- .3PCS-HEX KEY WRENCH 1.5, 2, 2.5

### 216 PCS SOCKET SET

- .13PCS-1/4"DR.SOCKET:4,4.5,5,5.5,6,7,8,9,10,11,12,13,14MM
- .5PCS-1/4"DR.TORX SOCKET:E4,E5,E6,E7,E8
- .7PCS-1/4"DR.DEEP SOCKET:4,5,6,7,8,9,10MM
- .1PC-1/4"DR.SLIDING T BAR
- .2PCS-1/4"DR.EXTENSION BAR:2",4"
- .1PC-1/4"DR.BIT HOLDER
- .1PC-1/4"DR.UNIVERSAL JOINT
- .1PC-1/4"DR.SPINNER HANDLE:6"
- .1PC-1/4"DR.QUICK RATCHET HANDLE
- .30PCS-1/4"DR.BIT SOCKETS:
- PH:2,3 PZ:2,3 SL:6,6.5,8 T:25,27,30,35,40x2,45,50.
- H:4,5,6,7,8 M:5,6,8,10 TT: 27,30,35,40,45,50.
- .10PCS-3/8"DR.SOCKET:10,11,12,13,14,15,16,17,18,19MM
- .6PCS-3/8"DR.TORX SOCKET:E10,E11,E12,E14,E16,E18
- .6PCS-3/8"DR.DEEP SOCKET:10,11,12,13,14,15MM
- .1PC-3/8"DR.SPARK PLUG SOCKET:18MM
- .1PC-3/8"DR.BIT HOLDER
- .1PC-3/8"DR.UNIVERSAL JOINT
- .1PC-3/8"DR.EXTENSION BAR: 5"
- .1PC-3/8"DR.QUICK RATCHET HANDLE
- .14PCS-1/2"DR.SOCKET:
- 10,12,13,14,15,17,19,20,21,22,24,27,30,32MM
- .3PCS-1/2"DR.TORX SOCKET:E20,E22,E24
- .5PCS-1/2"DR.DEEP SOCKET:16,17,18,19,22MM
- .2PCS-1/2"DR.EXTENSION BAR:5"&10"
- .1PC-1/2"DR.3-WAY ADAPTOR
- .1PC-1/2"DR.UNIVERSAL JOINT
- 1PC-1/2"DR.BIT HOLDER
- .2PCS-1/2"DR.SPARK PLUG SOCKET:16MM&21MM
- .1PC-1/2"DR.QUICK RATCHET HANDLE



Code:DS-100216

- .30PCS-BITS(8MM):
- H5,5,6,6.5,7,8,10 SL6,6.5,8 PH3,4 PZ3,4
- T27,30,35,40,45,50 TT27,30,35,40,45,50 M5,6,8,10,12
- .2PCS-1/2"DR.BIT SOCKETS: T55,T60
- .12PCS-SPANNER:8,9,10,11,12,13,14,15,16,17,18,19MM
- .7PCS-HEX KEY WRENCHES: 1,1.5,2,2.5,3,4,5MM
- .44PCS-BITS(6.35MM):
- PH0,1,2,3 PZ0,1,2,3 SL4,5,5.5,6,7 SLT4,6,8,10
- H2,2.5,3,4,5,6,7 T8,9,10,15,20,25,27,30,40
- TT8,9,10,15,20,25,27,30,40 S1,2,3
- .1PC-SCREWDRIVER
- .1PC-BLOW CASE

## 1/2" IMPACT BIT SET T

DESCRIPTION:  
 .8-SOCKET  
 T30-T40-T45-T50-T55-T60-T70-T80  
 .1-BLOW MOLDED CASE



## 1/2" DR 3PCS IMPACT DEEP SOCKET SET

Code:DS-2001

DESCRIPTION:  
 .3-SOCKET 17-19-21MM  
 .1-BLOW MOLDED CASE



## 1/2" IMPACT BIT SET H

DESCRIPTION:  
 .10-SOCKET  
 H5-H6-H7-H8-H10-H12-H14-H16-H17-H19  
 .1-BLOW MOLDED CASE



## 1/2" DR 3PCS BLACK DEEP SOCKET SET

Code:DS-2043

DESCRIPTION:  
 .3-SOCKET 17-19-21MM  
 .1-BLOW MOLDED CASE



## IMPACT SOCKET BIT WITH PLASTIC HANGLE

DESCRIPTION:  
 .7-SOCKET  
 RT6-RT7-RT8-RT10-RT11-RT12-RT13  
 .1-PLASTIC HANGER



## 1/2" 3/8" 1/4" DR 14PCS E SOCKET SET

Code:DS-2044

DESCRIPTION:  
 .1/4 DR 5 -E SOCKET E4-E5-E6-E7-E8  
 .3/8 DR 5 -E SOCKET E10-E11-E12-E14-E16  
 .1/2 DR 4 -E SOCKET E18-E20-E22-E24  
 .1-BLOW MOLDED CASE



## 1/2" DR 10PCS SOCKET SET

Code:DS-2053

DESCRIPTION:

- .9-SOCKET 10-12-13-14-16-17-19-22-24MM
- .1-L HANDLE 10"
- .1-BLOW MOLDED CASE



## 1/2" & 1/4" & 3/8" DR 171PCS STAHL KRAFT GERMANY SOCKET SET

Code:DS-2050

- .13-1/4" DR METRIC SOCKET:4,4.5,5,5.5,6,7,8,9,10,11,12,13,14MM
- .5-1/4" DR TORX SOCKET:E4,E5,E6,E7,E8
- .7-1/4" DR DEEP SOCKET:4,5,6,7,8,9,10MM
- .2-1/4" DR EXTENSION BAR:2"&4"
- .1-1/4" DR SLIDING T BAR
- .1-1/4" DR SPINNER HANDLE:6"
- .30-1/4" DR BIT  
SOCKETS:H2,3,4,5,6 FD4,5,5,7 PH1,2,3 T8,9,10,15 T20, 25,27,30 TT8,9,10,15,20,25,27,30
- .10-3/8" DR SOCKET:10,11,12,13,14,15,16,17,18,19MM
- .6-3/8" DR TORX SOCKETS:E10,E11,E12,E14,E16,E18
- .6-3/8" DEEP SOCKETS:10,11,12,13,14,15MM
- .1-3/8" DR EXTENSION BARS:6"
- .17-1/2" DR METRIC SOCKETS:10,11,12,13,14,15,16, 17,18,19,20,21,22,24,27,30,32MM
- .2-1/2" DR TORX SOCKETS:E20,E24
- .5-1/2" DR DEEP SOCKETS:16,17,18,19,22MM
- .2-1/2" DR SPARK PLUG SOCKETS:16&21MM
- .2-1/2" DR EXTENSION BARS:5" &10"
- .1-3-WAY-ADAPTER
- .3-QUICK RATCHET HANDLE:1/4" &3/8" &1/2"
- .3-UNIVERSAL JOINT:1/4" &3/8" &1/2"
- .2-3/8" &1/2" DR BIT HOLDER
- 24-BITS:  
.H7,8,10,12,14 FD8,10,12 PH3.4 PZ3,4  
.T40,45,50,55,60,70 TT40,45,50,55,60,70
- .7-HEX KEY WRENCHES:1.5,2,2.5,3,4,5,6MM
- .10-BITS:T8,9,10,15,20,25,30,4,5,5,7
- .1-1/4" DR BIT HOLDER
- .1-BLOW CASE



## 1/2" DR 32PCS SCOKET SET

Code:DS-2045

DESCRIPTION:

- .18-6PT SOCKET 8-9-10-11-12-13-14-15-16-17-18-19-20-21-22-24-27-30-32MM
- .6-12PT SOCKET 10-12-14-15-17-19MM
- .1-T-BAR ADAPTOR 3/8DR(F)X1/2DR(M)
- .2UNIVERSAL JOINT
- .2-EXTENSION BAR 5" -10"
- .1-SPARK PLUG 21MM 16MM
- .1-RATCHET HANDLE 72T
- .1-BLOW MOLD CASE



## 1/2" DR 37PCS SOCKET SET

Code:DS-2046

DESCRIPTION:

- .19-1/2" SOCKET 8,9,10,11,12,13,14,15,16,17,18,19, 20,21,22,24,27,30,32MM
- .2-1/2" SPARK PLUG SOCKET 16MM,21MM
- .1-1/2" EXTENSION BAR 10"
- .1-1/2" UNIVERSAL JOINT
- .1-6 WAY ADAPTOR
- .1-1/2" RATCHET HANDLE 72T
- .12-COMBINATION SPANNERS 8,9,10,11,12,13,14,15, 16,17,18,19MM
- .1-BLOW MOLDED CASE



**1/2" DR 24PCS SOCKET SET**

**Code:DS-2015**

**DESCRIPTION:**

- .18-6PT SOCKET 10-11-12-13-14-15-17-18-19-20-21-22-23-24-27-30-32MM
- .1-SPARK PLUG 21MM
- .1-RATCHET HANDLE 24T
- .1-SLIDING T HANDLE 10"
- .1-UNIVERSAL JOINT
- .2-EXTENSION BAR 5" -10"
- .1-METAL BOX



**1/2" DR 9PCS DRIVES BIT SOCKET SET**

**Code:DS-2034**

**DESCRIPTION:**

- .9-DRIVER BIT SOCKET H4-H5-H6-H8-H10-H12-H17-H19
- .1-METAL CASE



**1/2" DR 24PCS SOCKET SET**

**Code:DS-2018**

**DESCRIPTION:**

- .18-6PC SOCKET 10-11-12-13-14-15-17-18-19-20-21-22-23-24-27-30-32MM
- .1-RATCHET HANDLE
- .1-SLIDING T HANDLE 10"
- .1-SPEED HANDLE
- .1-UNIVERSAL JOINT
- .2-EXTENSION BAR 5" -10"
- .1-METAL CASE



**1/2" DR 16PCS DRIVES BIT SOCKET SET**

**Code:DS-2035**

**DESCRIPTION:**

- .9-1/2" DR E SOCKET E10-E11-E12-E14-E16-E18-E20-E22-E24MM
- .7-1/2" DR DRIVER SOCKET T40-T45-T50-T55-T60-T70
- .1-METAL CASE



**1/2" DR 24PCS SOCKET SET**

**Code:DS-2031**

**DESCRIPTION:**

- .18-6PC SOCKET 10-11-12-13-14-15-17-18-19-20-21-22-23-24-27-30-32MM
- .2-EXTENSION BAR 5" -10"
- .1-SLIDING BAR 10"
- .1-SPEED HANDLE
- .1-UNIVERSAL JOINT
- .1-RATCHET HANDLE 24T
- .1-METAL CASE



**1/2" DR 8PCS DRIVES BIT SOCKET SET(100MM)**

**Code:DS-2036**

**DESCRIPTION:**

- .9-DRIVER BIT SOCKET T20-T30-T40-T45-T50-T55-T60-T70
- .1-METAL CASE



**1/4" ,3/8" ,1/2" DR RATCHET HANDLE**



ITEM NO.	□	L(MM)	g
DS-10001A	1/4"	150.0	138.0
DS-10001B	3/8"	220.0	370.0
DS-10001C	1/2"	260.0	433.0

1/2" 1/4" 3/8" RATCHET 45T  
72T DIN 3122 MICRO FINISH NON-SLIP

**1/4" ,3/8" ,1/2" DR RATCHET HANDLE**



ITEM NO.	□	L(MM)	g
DS-11001A	1/4"	150.0	138.0
DS-11001B	3/8"	220.0	370.0
DS-11001C	1/2"	260.0	433.0

1/2" 1/4" 3/8" RATCHET 45T  
72T DIN 3122 MICRO FINISH NON-SLIP

**1/4" ,3/8" ,1/2" DR RATCHET HANDLE**



ITEM NO.	□	L(MM)	g
DS-15001	1/4"	150.0	138.0
DS-15002	3/8"	220.0	370.0
DS-15003	1/2"	260.0	433.0

1/2" 1/4" 3/8" RATCHET  
72T DIN 3122 MICRO FINISH NON-SLIP

**1/4" ,3/8" ,1/2" DR RATCHET HANDLE**



ITEM NO.	□	L(MM)	g
NFF-16001	1/4"	150.0	138.0
NFF-16001	3/8"	220.0	370.0
NFF-16001	1/2"	260.0	433.0

1/2" 1/4" 3/8" RATCHET 45T  
72T DIN 3122 MICRO FINISH NON-SLIP

**1/2" DR RATCHET HANDLE**



ITEM NO.	□	L(MM)	g
NFF-16001	1/2"	305.0-445.0	936.0

1/2" RATCHET 72T  
DIN 3122 MICRO FINISH NON-SLIP

**WHEEL MASTER WRENCH**



Code:DS-1001

ITEM NO.	S(mm)	G.W/N.W(g)	Qty/Ctn(pcs)
DS-1001A	17x19	21.0/20.0	20.0
DS-1001B	17x19 21x23	23.0/22.0	20.0

**1/4" DR DEEP SOCKET**

ITEM NO.	S(MM)	H(MM)	L(MM)	g
NFD-1001D	4.0	11.8	50.0	20.0
1002D	5.0	11.8	50.0	21.0
1003D	6.0	11.8	50.0	23.0
	7.0	11.8	50.0	23.0
	8.0	11.8	50.0	24.0
	9.0	12.8	50.0	29.0
	10.0	14.5	50.0	38.0
	11.0	15.8	50.0	44.0
	12.0	16.8	50.0	53.0
	13.0	17.8	50.0	51.0
	14.0	19.8	50.0	68.0

**3/8" DR DEEP SOCKET**

ITEM NO.	S(MM)	H(MM)	L(MM)	g
NFD-1001D	6.0	16.8	63.0	54.0
1002D	7.0	16.8	63.0	54.0
1003D	8.0	16.8	63.0	54.0
	9.0	16.8	63.0	54.0
	10.0	16.8	63.0	58.0
	11.0	16.8	63.0	58.0
	12.0	16.8	63.0	68.0
	13.0	17.8	63.0	62.0
	14.0	19.8	63.0	82.3
	15.0	21.8	63.0	110.0
	16.0	21.8	63.0	112.0
	17.0	23.8	63.0	122.0
	18.0	25.8	63.0	131.0
	19.0	25.8	63.0	132.0
	20.0	27.8	63.0	148.7
	21.0	27.8	63.0	149.1
	22.0	29.8	63.0	172.8
	23.0	29.8	63.0	201.7
	24.0	29.8	63.0	196.9

**1/2" DR DEEP SOCKET**

ITEM NO.	S(MM)	H(MM)	L(MM)	g
NFD-1001D	8.0	21.8	78.0	105.0
1002D	9.0	21.8	78.0	104.0
1003D	10.0	21.8	78.0	103.0
	11.0	21.8	78.0	104.9
	12.0	21.8	78.0	109.0
	13.0	21.8	78.0	118.0
	14.0	21.8	78.0	115.0
	15.0	21.8	78.0	114.0
	16.0	21.8	78.0	109.9
	17.0	23.8	78.0	139.0
	18.0	24.8	78.0	176.0
	19.0	23.8	78.0	163.0
	20.0	25.8	78.0	202.5
	21.0	25.8	78.0	191.0
	22.0	27.8	78.0	231.0
	23.0	27.8	78.0	235.0
	24.0	29.8	78.0	227.0
	25.0	29.8	78.0	252.1
	27.0	29.8	78.0	293.0
	30.0	29.8	78.0	366.0
	32.0	29.8	78.0	399.0

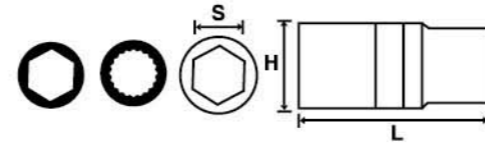

**1/4" DR SOCKET**

ITEM NO.	S(MM)	H(MM)	L(MM)	g
DS-1001	4.0	11.8	25.0	10.0
DS-1002	4.5	11.8	25.0	10.0
DS-1003	5.0	11.8	25.0	10.0
DS-1004	5.5	11.8	25.0	10.0
DS-1005	6.0	11.8	25.0	10.0
DS-1006	7.0	11.8	25.0	13.5
DS-1007	8.0	11.8	25.0	12.5
DS-1008	9.0	12.8	25.0	14.0
DS-1009	10.0	14.5	25.0	18.0
DS-1010	11.0	15.8	25.0	22.0
DS-1011	12.0	16.8	25.0	25.0
DS-1012	13.0	17.8	25.0	26.0
DS-1013	14.0	19.8	25.0	35.0

**3/8" DR SOCKET**

ITEM NO.	S(MM)	H(MM)	L(MM)	g
DS-2001	6.0	16.8	28.0	22.0
DS-2002	7.0	16.8	28.0	22.0
DS-2003	8.0	16.8	28.0	23.5
DS-2004	9.0	16.8	28.0	23.5
DS-2005	10.0	16.8	28.0	23.5
DS-2006	11.0	16.8	28.0	21.5
DS-2007	12.0	16.8	28.0	23.5
DS-2008	13.0	17.8	28.0	28.5
DS-2009	14.0	19.8	28.0	33.5
DS-2010	15.0	21.8	28.0	45.5
DS-2011	16.0	21.8	28.0	43.5
DS-2012	17.0	23.8	30.0	56.5
DS-2013	18.0	25.8	30.0	70.5
DS-2014	19.0	25.8	30.0	67.0
DS-2015	20.0	27.8	30.0	78.0
DS-2016	21.0	27.8	30.0	75.5
DS-2017	22.0	29.8	30.0	96.5
DS-2018	23.0	29.8	32.0	101.0
DS-2019	24.0	29.8	32.0	115.0

**1/2" DR SOCKET**

ITEM NO.	S(MM)	H(MM)	L(MM)	g
DS-3001	8.0	21.8	38.0	42.0
DS-3002	9.0	21.8	38.0	44.0
DS-3003	10.0	21.8	38.0	46.0
DS-3004	11.0	21.8	38.0	47.0
DS-3005	12.0	21.8	38.0	51.0
DS-3006	13.0	21.8	38.0	53.0
DS-3007	14.0	21.8	38.0	54.0
DS-3008	15.0	21.8	38.0	57.0
DS-3009	16.0	21.8	38.0	54.0
DS-3010	17.0	23.8	38.0	67.0
DS-3011	18.0	24.8	38.0	72.0
DS-3012	19.0	25.8	38.0	70.0
DS-3013	20.0	27.8	38.0	79.0
DS-3014	21.0	27.8	38.0	75.0
DS-3015	22.0	29.8	38.0	95.0
DS-3016	23.0	31.8	40.0	104.0
DS-3017	24.0	31.8	40.0	100.0
DS-3018	25.0	33.8	42.0	117.0
DS-3019	27.0	35.8	43.0	134.0
DS-3020	30.0	39.8	44.0	194.0
DS-3021	32.0	41.8	45.0	209.0



A 镜面光身 B 镜面凤梨花纹 C 镜面双沟纹 D 镜面直纹

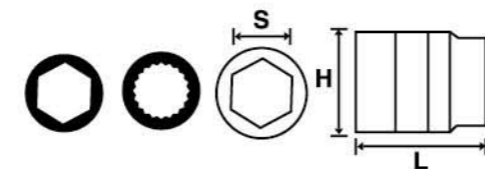

**1/4" DR DRIVER BIT SOCKET**  
(Cross Head Phillips Screws)

ITEM NO.	⊕	H(mm)	L(mm)	g
DS-PH1001A	PH1.0	12.0	37.0	12.0
DS-PH1002A	PH2.0	12.0	37.0	12.0
DS-PH1003A	PH3.0	12.0	37.0	18.0

**3/8" DR DRIVER BIT SOCKET**  
(Cross Head Phillips Screws)

ITEM NO.	⊕	H(mm)	L(mm)	g
DS-PH1001B	PH1.0	16.8	48.0	35.0
DS-PH1002B	PH2.0	16.8	48.0	38.0
DS-PH1003B	PH3.0	16.8	48.0	38.0
DS-PH1004B	PH4.0	16.8	48.0	39.0

**1/2" DR DRIVER BIT SOCKET**  
(Cross Head Phillips Screws)

ITEM NO.	⊕	H(mm)	L(mm)	g
DS-PH1001C	PH1.0	16.8	60.0	77.0
DS-PH1002C	PH2.0	16.8	60.0	77.0
DS-PH1003C	PH3.0	16.8	60.0	77.0

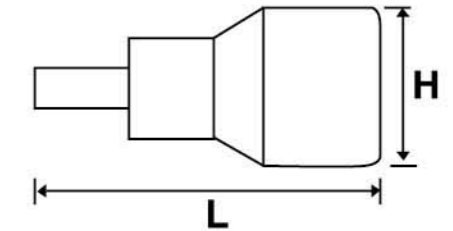

**1/4" DR DRIVER BIT SOCKET**  
(Torx Head Screws)

ITEM NO.	⊕	H(mm)	L(mm)	g
DS-TR1001A	T9.0	12.0	37.5	12.0
DS-TR1002A	T10.0	12.0	37.5	12.0
DS-TR1003A	T15.0	12.0	37.5	13.0
DS-TR1004A	T20.0	12.0	37.5	14.0
DS-TR1005A	T25.0	12.0	37.5	14.0
DS-TR1006A	T30.0	12.0	37.5	15.0
DS-TR1007A	T40.0	12.0	37.5	16.0

**1/2" DR DRIVER BIT SOCKET**  
(Torx Head Screws)

ITEM NO.	⊕	H(mm)	L(mm)	g
DS-TR1001C	20.0	16.8	60.0	72.0
DS-TR1002C	25.0	16.8	60.0	70.0
DS-TR1003C	27.0	16.8	60.0	72.0
DS-TR1004C	30.0	16.8	60.0	75.0
DS-TR1005C	40.0	16.8	60.0	75.0
DS-TR1006C	45.0	16.8	60.0	75.0
DS-TR1007C	50.0	16.8	60.0	82.0
DS-TR1008C	55.0	16.8	60.0	85.0
DS-TR1009C	60.0	16.8	60.0	115.0

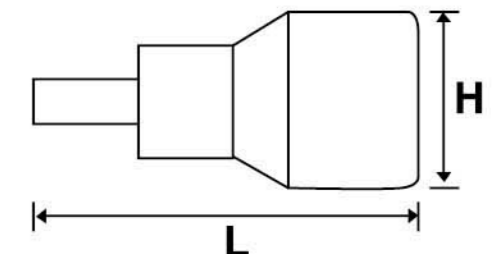

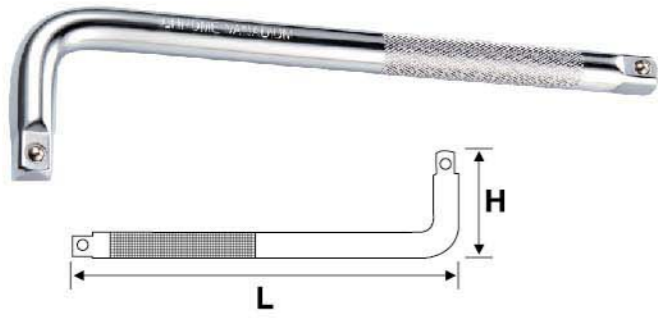

**1/2" DR L HANDLE**

ITEM NO.	L(MM)
DS-8001C	10"
DS-8002C	12"
DS-8003C	14"



**1/2" DR THREE WAY ADAPTOR**

ITEM NO.	S(")	g
DS-6001C	3/8X1/2	55.0
DS-6002C	1/2X3/8	55.0

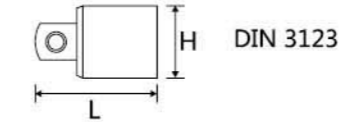

**1/4" DR EXTENSION BAR**

ITEM NO.	S(")	H(mm)	L(mm)	g
DS-3001A	2"	12.3	50.0	23.0
DS-3002A	4"	12.3	110.0	44.0
DS-3003A	6"	12.3	150.0	64.0

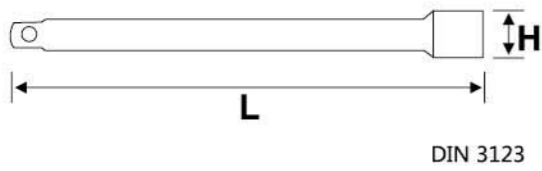

**1/2" DR EXTENSION BAR**

ITEM NO.	S(")	H(mm)	L(mm)	g
DS-3001C	3"	21.8	75.0	138.0
DS-3002C	5"	21.8	150.0	370.0
DS-3003C	10"	21.8	250.0	433.0

**3/8" DR EXTENSION BAR**

ITEM NO.	S(")	H(mm)	L(mm)	g
DS-3001B	3"	16.8	75.0	75.0
DS-3002B	6"	16.8	150.0	146.0



**1/2" DR UNIVERSAL JOINTS**

ITEM NO.	S(")	H(mm)	L(mm)	g
DS-7001A	1/4"	14.0	38.0	22.0

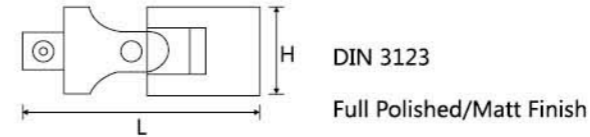

**3/8" DR UNIVERSAL JOINTS**

ITEM NO.	S(")	H(mm)	L(mm)	g
DS-7001B	3/8"	18.0	55.0	67.0

**1/2" DR UNIVERSAL JOINTS**

ITEM NO.	S(")	H(mm)	L(mm)	g
DS-7001C	1/2"	24.8	73.0	151.0



**1/4" DR SLIDING BAR**

ITEM NO.	S(")	H(mm)	L(mm)	g
DS-1001A	1/4"	24.0	115.0	45.0

**1/2" DR SLIDING BAR**

ITEM NO.	S(")	H(mm)	L(mm)	g
DS-1001C	1/2"	42.0	250.0	353.0

**3/8" DR SLIDING BAR**

ITEM NO.	S(")	H(mm)	L(mm)	g
DS-1001B	3/8"	32.0	165.0	160.0

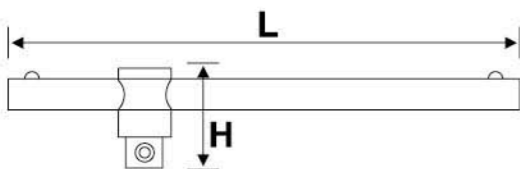

**1/2" DR F HANDLE**

ITEM NO.	L(")
DS-9001C	15"
DS-9002C	18"
DS-9003C	24"

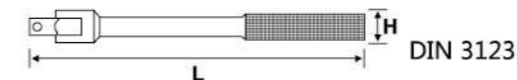



**1/2" DR EXTENSION BAR**

ITEM NO.	S( )	L(MM)	g
DS-4001C	10"	250.0	350.0

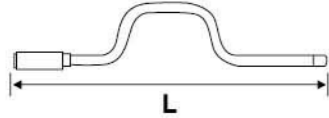

**3/8" DR SPARK PLUG SOCKET**

ITEM NO.	S(MM)	H(MM)	L(MM)	g
DS5001B	16.0	22.0	62.0	100.0
DS5001B	21.0	28.0	62.0	180.0

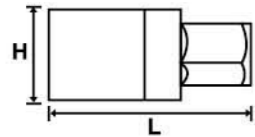

DIN 3122

**1/2" DR SPARK PLUG SOCKET**

ITEM NO.	S(MM)	H(MM)	L(MM)	g
DS-5001C	16.0	22.0	62.0	100.0
DS-5001C	21.0	28.0	62.0	180.0



**1/2" DR IMPACT SOCKET**

ITEM NO.	S(MM)	H(MM)	L(MM)	g
DS-Q1001	8.0	24.0	38.0	80.0
DS-Q1002	9.0	24.0	38.0	80.0
DS-Q1003	10.0	24.0	38.0	79.0
DS-Q1004	11.0	24.0	38.0	80.3
DS-Q1005	12.0	24.0	38.0	78.0
DS-Q1006	13.0	24.0	38.0	75.0
DS-Q1007	14.0	24.0	38.0	77.0
DS-Q1008	15.0	24.0	38.0	80.0

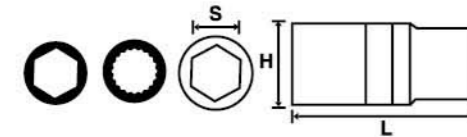

ITEM NO.	S(MM)	H(MM)	L(MM)	g
DS-Q1009	16.0	24.0	38.0	76.0
DS-Q1010	17.0	26.0	38.0	97.0
DS-Q1011	18.0	28.0	38.0	121.0
DS-Q1012	19.0	28.0	38.0	103.0
DS-Q1013	20.0	30.0	38.0	130.0
DS-Q1014	21.0	30.0	38.0	122.0
DS-Q1015	22.0	32.0	38.0	143.0
DS-Q1016	23.0	34.0	40.0	172.0

ITEM NO.	S(MM)	H(MM)	L(MM)	g
DS-Q1017	24.0	34.0	40.0	165.0
DS-Q1018	25.0	36.0	42.0	180.0
DS-Q1019	26.0	36.0	42.0	77.0
DS-Q1020	27.0	38.0	42.0	80.0
DS-Q1021	28.0	40.0	42.0	76.0
DS-Q1022	29.0	40.0	42.0	97.0
DS-Q1023	30.0	42.0	43.0	121.0
DS-Q1024	32.0	44.0	43.0	103.0



**1/2" DR DEEP IMPACT SOCKET**

ITEM NO.	S(MM)	H(MM)	L(MM)	g
DS-Q1001D	8.0	24.0	78.0	189.0
DS-Q1002D	9.0	24.0	78.0	188.0
DS-Q1003D	10.0	24.0	78.0	186.5
DS-Q1004D	11.0	24.0	78.0	181.5
DS-Q1005D	12.0	24.0	78.0	180.0
DS-Q1006D	13.0	24.0	78.0	176.5

ITEM NO.	S(MM)	H(MM)	L(MM)	g
DS-Q1007D	14.0	24.0	78.0	166.5
DS-Q1008D	15.0	24.0	78.0	159.0
DS-Q1009D	16.0	24.0	78.0	15.0
DS-Q1010D	17.0	26.0	78.0	187.0
DS-Q1011D	18.0	28.0	78.0	228.0
DS-Q1012D	19.0	28.0	78.0	212.0

ITEM NO.	S(MM)	H(MM)	L(MM)	g
DS-Q1013D	20.0	30.0	78.0	260.0
DS-Q1014D	21.0	30.0	78.0	248.0
DS-Q1015D	22.0	32.0	78.0	291.0
DS-Q1016D	23.0	34.0	78.0	339.0
DS-Q1017D	24.0	34.0	78.0	323.0

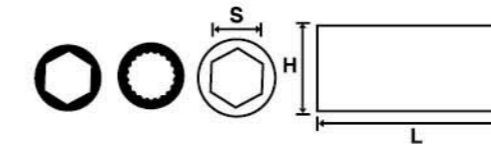

**1/2" DR MULTI SOCKET**

ITEM NO.	S(MM)	H(MM)	L(MM)	g
DS-4001	8.0	21.8	38.0	42.0
DS-4002	9.0	21.8	38.0	44.0
DS-4003	10.0	21.8	38.0	46.0
DS-4004	11.0	21.8	38.0	47.0
DS-4005	12.0	21.8	38.0	51.0
DS-4006	13.0	21.8	38.0	53.0
DS-4007	14.0	21.8	38.0	54.0
DS-4008	15.0	21.8	38.0	57.0

ITEM NO.	S(MM)	H(MM)	L(MM)	g
DS-4009	16.0	21.8	38.0	54.0
DS-4010	17.0	23.8	38.0	67.0
DS-4011	18.0	24.8	38.0	72.0
DS-4012	19.0	23.8	38.0	70.0
DS-4013	20.0	25.8	38.0	79.0
DS-4014	21.0	25.8	38.0	75.0
DS-4015	22.0	27.8	38.0	95.0
DS-4016	23.0	27.8	40.0	104.0

ITEM NO.	S(MM)	H(MM)	L(MM)	g
DS-4017	24.0	29.8	40.0	100.0
DS-4018	25.0	29.8	42.0	117.0
DS-4019	27.0	29.8	43.0	134.0
DS-4020	30.0	29.8	44.0	194.0
DS-4021	32.0	29.8	45.0	209.0

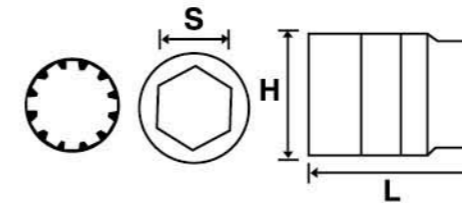

**1/4" DR SQUARE EXTENSION BAR**

ITEM NO.	S( )	L(MM)	g
DS-2001A	1/4"	115.0	100.0

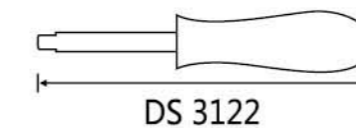

DS 3122

产品货号页码对照表

棘轮扳手系列/Ratchet Wrench	
产品货号	页码
KT2016 KT2012	P06
KT2017 KT2018	P07
KT2011 KT2013	P08
KT2015 KT2014	P09
DSH1501 DSH1502 DSH1503 DSH1504 DSH1505 DSH1506 DSH1507 DSH1508 DSH1509 DSH1510 DSH1511 DSH1512 DSH1513 DSH1514 DSH1515 DSH1516	P11
DSD1601 DSS1602 DSS1603 DSL1701 DSL1702	P12
摇头套筒系列/Flexible Socket Wrench	
产品货号	页码
YT101 YT102 SYT101 SYT102	P14
活动扳手系列/Adjustable Wrench	
产品货号	页码
KT401 KT402 KT403 KT404	P16
E型扳手/Star Wrench	
产品货号	页码
KTE605	P17
直柄梅花/Long Type Double Ring Spanner	
产品货号	页码
KT607	P18
S型扳手/S Type Spanner	
产品货号	页码
KT901	P19
U型扳手/U Type Spanner	
产品货号	页码
KT902	P20
油管扳手/Flare Nut Wrench	
产品货号	页码
KT903	P22
两用扳手系列/Combination Spanner	
产品货号	页码
KT701	P25
KT702	P26
KT705	P27
KT704	P28
KT703	P29
KT304	P30

开口扳手系列/Double Open End Spanner	
产品货号	页码
KT501	P33
KT506	P34
KT505	P35
KT504	P36
KT503 KT501	P37
KT501	P38
梅花扳手系列/Double Offset Ring Spanner	
产品货号	页码
KT601	P39
KT605	P40
KT606	P41
KT604	P42
KT603	P43/P44
KT602	P39/P45
万能扳手/Universal Wrench	
产品货号	页码
KT091 KT092	P47
拉马/Puller	
产品货号	页码
LM907 LM906	P48
8合1组合套筒 / 8 in 1 Combination Wrench	
产品货号	页码
KT1101	P48
T型六角套筒/T Type Wrench	
产品货号	页码
KT801S	P49
磁性强力套筒/Magnetic Nut Wrench 三叉扳手/Y Type Wrench	
产品货号	页码
KT802 KT803	P50
内六角扳手系列/Hex Key	
产品货号	页码
KTN2100 KTN2101 KTN2200 KTN2201 KTN2300 KTN2301 KTN2400 KTN2500 KTN2600	P51/52
KTN-3100 KTN-3101 KTN-3102 KTN-3103 KTN-3104 KTN-3105 KTN-3106 KTN-3107 KTN-3108 KTN-3109 KTN-3110 KTN-3111 KTN-3112 KTN-3113 KTN-3114	P53
KTN-3200 KTN-3201 KTN-3202 KTN-3203 KTN-3204 KTN-3205 KTN-3206 KTN-3207 KTN-3208 KTN-3209 KTN-3210 KTN-3211 KTN-3212 KTN-3213 KTN-3214	

产品货号页码对照表

内六角扳手系列/Hex Key	
产品货号	页码
KTN-3301 KTN-3302 KTN-3303 KTN-3304 KTN-3305 KTN-3306 KTN-3307 KTN-3308 KTN-3309 KTN-3310 KTN-3400 KTN-3401 KTN-3402 KTN-3403 KTN-3404 KTN-3405 KTN-3406 KTN-3407 KTN-3408 KTN-3409 KTN-3410 KTN-3411 KTN-3412 KTN-3413 KTN-3414	P54
KTN-3500 KTN-3501 KTN-3502 KTN-3503 KTN-3504 KTN-3505 KTN-3506 KTN-3507 KTN-3508 KTN-3509 KTN-3510 KTN-3511 KTN-3512 KTN-3513 KTN-3514	P55
KTN-3600 KTN-3601 KTN-3602 KTN-3603 KTN-3604 KTN-3605 KTN-3606 KTN-3607 KTN-3608 KTN-3609 KTN-3610 KTN-3611	P56
KTN-4601 KTN-4602 KTN-4603 KTN-4604 KTN-4701 KTN-4702 KTN-4703 KTN-4704 KTN-4705 KTN-4706	
KTN-4601 KTN-4602 KTN-4603 KTN-4604 KTN-4605 KTN-4000 KTN-4001 KTN-4002 KTN-4003 KTN-4004 KTN-4005 KTN-4006 KTN-4007 KTN-4008 KTN-4009	P57
KTN-4711 KTN-4712 KTN-4713 KTN-3400 KTN-3401 KTN-3402 KTN-3403 KTN-3404 KTN-3405 KTN-3406 KTN-3407 KTN-3408 KTN-3409 KTN-3410 KTN-3411 KTN-3412 KTN-3413 KTN-3414 KTN-4301 KTN-4302 KTN-4303 KTN-4304 KTN-4305 KTN-4306	P58
KTN-4401 KTN-4402 KTN-4403 KTN-4404 KTN-4405 KTN-4406 KTN-4501 KTN-4502 KTN-4503 KTN-4504 KTN-4505 KTN-4506	P59
KTN-4300 KTN-4301 KTN-4302 KTN-4303 KTN-4304 KTN-4305 KTN-4306 KTN-4307 KTN-4308 KTN-4309 KTN-4310 KTN-4311 KTN-4312 KTN-4313 KTN-4314 KTN-4315 KTN-4701 KTN-4702 KTN-4703 KTN-4704 KTN-4705 KTN-4706 KTN-4200 KTN-4203	P60
套筒系列/Socket	
产品货号	页码
DS-1003 DS-1005 DS-1006 DS-1007	P62
DS-1008 DS-2058 DS-1012	P63
DS-2053 DS-2054 DS-2055 DS-1017 DS-1056 DS-2056	P64
DS-100029 DS-100032 DS-100056	P65
DS-100076 DS-100082	P66
DS-100088 DS-100094	P67
DS-100108 DS100216	P68
DS-2001 DS-2043 DS-2044	P70
DS-2053 DS-2050	P71
DS-2045 DS-2046	P72
DS-2015 DS-2018 DS-2031	P73
DS-2034 DS-2035 DS-2036	P74
DS-10001A DS-10001B DS-10001C DS-11001C DS-15001 DS-15002 DS-15003	P75
NFF-16001 DS-1001A DS-1001B	P76

套筒系列/Socket	
产品货号	页码
NFD-1001D 1002D 1003D DS-1001 DS-1002 DS-1003 DS-1004 DS-1005 DS-1006 DS-1007 DS-1008 DS-1009 DS-1010 DS-1011 DS-1012 DS-1013	P77
DS-2001 DS-2002 DS-2003 DS-2004 DS-2005 DS-2006 DS-2007 DS-2008 DS-2009 DS-2010 DS-2011 DS-2012 DS-2013 DS-2014 DS-2015 DS-2016 DS-2017 DS-2018 DS-2019	
DS-3001 DS-3002 DS-3003 DS-3004 DS-3005 DS-3006 DS-3007 DS-3008 DS-3009 DS-3010 DS-3011 DS-3012 DS-3013 DS-3014 DS-3015 DS-3016 DS-3017 DS-3018 DS-3019 DS-3020 DS-3021	P78
DS-PH1001A DS-PH1002A DS-PH1003A DS-PH1001B DS-PH1002B DS-PH1003B DS-PH1004B DS-PH1001C DS-PH1002C DS-PH1003C DS-TR1001A DS-TR1002A DS-TR1003A DS-TR1004A DS-TR1005A DS-TR1006A DS-TR1007A	
DS-TR1001C DS-TR1002C DS-TR1003C DS-TR1004C DS-TR1005C DS-TR1006C DS-TR1007C DS-TR1008C DS-TR1009C	P79
DS-8001C DS-8002C DS-8003C DS-3001A DS-3002A DS-3003A DS-3001C DS-3002C DS-3003C DS-3001B DS-3002B DS-1001A DS-1001C DS-1001B	
DS-6001C DS-6002C DS-7001A DS-7001B DS-7001C DS-9001C DS-9002C DS-9003C	P80
DS-4001C DS5001B DS5001B DS-5001C DS-Q1001 DS-Q1002 DS-Q1003 DS-Q1004 DS-Q1005 DS-Q1006 DS-Q1007 DS-Q1008 DS-Q1009 DS-Q1010 DS-Q1011 DS-Q1012 DS-Q1013 DS-Q1014 DS-Q1015 DS-Q1016 DS-Q1017 DS-Q1018 DS-Q1019 DS-Q1020 DS-Q1021 DS-Q1022 DS-Q1023 DS-Q1024	P81
DS-Q1002D DS-Q1003D DS-Q1004D DS-Q1005D DS-Q1006D DS-Q1007D DS-Q1008D DS-Q1009D DS-Q1010D DS-Q1011D DS-Q1012D DS-Q1013D DS-Q1014D DS-Q1015D DS-Q1016D DS-Q1017D	P82
DS-4001 DS-4002 DS-4003 DS-4004 DS-4005 DS-4006 DS-4007 DS-4008 DS-4009 DS-4010 DS-4011 DS-4012 DS-4013 DS-4014 DS-4015 DS-4016 DS-4017 DS-4018 DS-4019 DS-4020 DS-4021 DS-2001A	